

# Sartorius Master<sup>pro</sup> Series

LP Models  
Electronic Precision Balances  
Operating Instructions

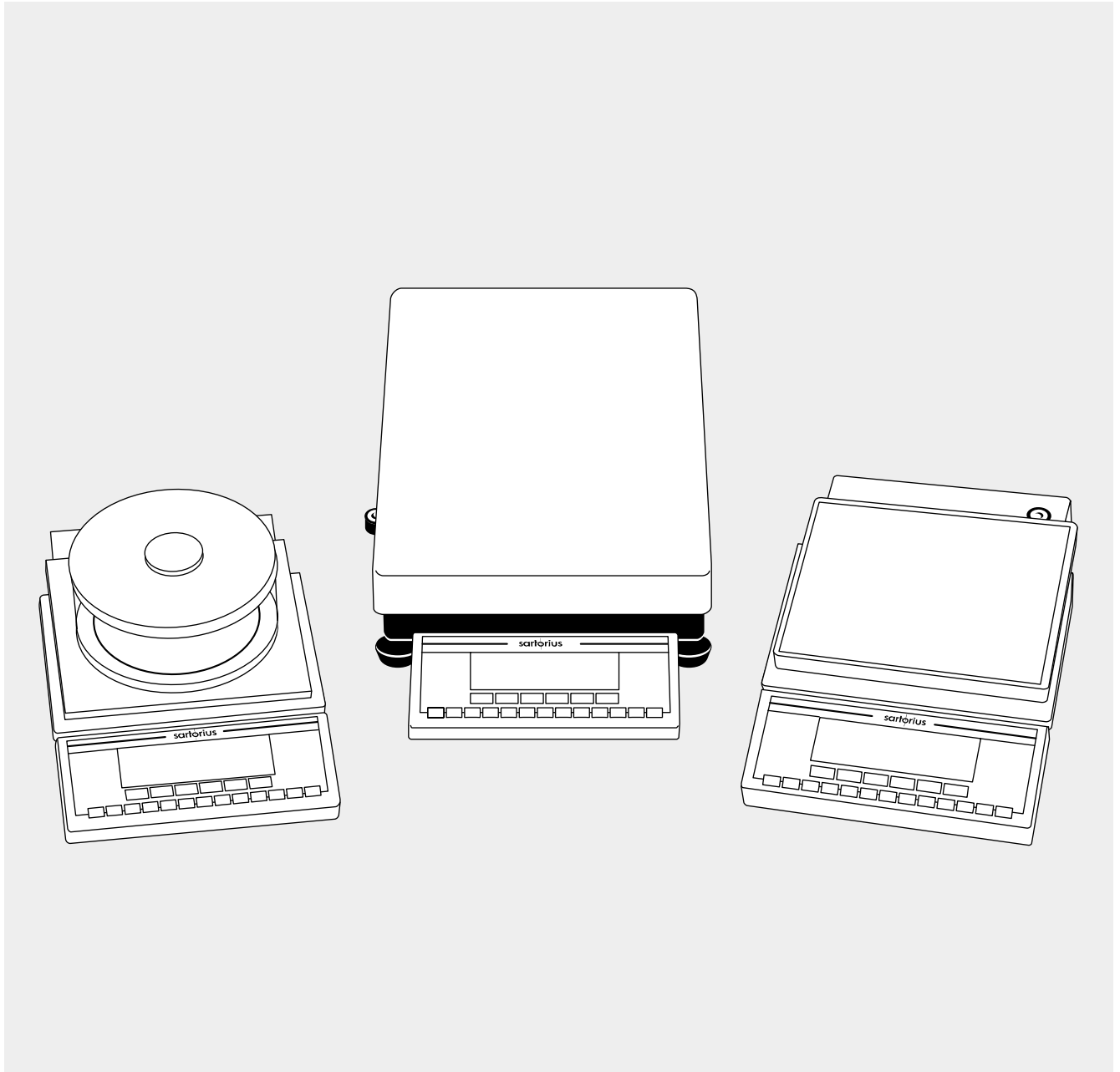

## Intended Use

The Master<sup>PRO</sup> Series from Sartorius offers precision balances with capacities ranging from 1 to 34 kg. A broad range of special performance features make the Master<sup>PRO</sup> balances ideal for use as measuring and test equipment in ISO or GLP quality management systems. These features include:

- Fully automatic self-calibrating and adjustment function, isoCAL (time- and temperature-dependent)
- reproTEST for quick determination of the standard deviation to check the reproducibility of results
- ISO/GLP-compliant recording capability for printouts
- Password-protected menu lock

Master<sup>PRO</sup> balances meet the highest requirements on the accuracy and reliability of weighing results through the following features:

- Efficient filtering-out of vibration
- Stable and reproducible results
- Excellent readability under any lighting conditions
- Rugged, durable weighing system

Master<sup>PRO</sup> balances save work and speed up simple routine applications through:

- Ultrafast response times
- Built-in applications (counting, animal weighing, weighing in percent, etc.)
- Automatic initialization when you switch on the balance
- Easy input of alphanumeric sample, lot and balance IDs
- Flexible, easy-to-use display and control unit
- Connectivity for control through an on-line computer

## Contents

Intended Use .....	2
Contents .....	2
Warnings and Safety Precautions .....	2
Operating Design .....	3
Getting Started .....	5
Configuring the Balance	
Setting the Language .....	10
'Info' Display .....	10
Entering User Data (Input) .....	11
Setting Parameters (Menu) .....	14
Operating the Balance	
Basic Weighing Function .....	21
Calibration/Adjustment .....	24
ReproTEST .....	30
Application Programs	
Toggle between	
Weight Units .....	31
Counting .....	33
Weighing in Percent .....	36
Net-Total Formulation .....	40
Animal Weighing .....	42
Checkweighing .....	46
Recalculation .....	51
Data Output Functions .....	56
Pin Assignment Chart .....	68
Cabling Diagram .....	69
Additional Functions .....	70
MP8 Interface Emulation .....	72
Error Codes .....	73
Care and Maintenance .....	75
Instructions for Recycling .....	76
Overview	
General Views	
of the Balances .....	77
Description of the Keys .....	80
Menu Structure .....	81
Specifications .....	82
Accessories (Options) .....	88
Declaration of Conformity .....	90
EC Type-Approval Certificates ..	93
Plates and Markings .....	96
Index .....	97
Appendix	
Entering the User Password	

## Warnings and Safety Precautions

This balance has been constructed in accordance with the European Directives as well as international regulations and standards for operation of electrical equipment, electromagnetic compatibility, and stipulated safety requirements. Improper use or handling, however, can result in damage and/or injury.

Read these operating instructions thoroughly before using your balance to prevent damage to the equipment. Keep these instructions in a safe place.

Follow the instructions below to ensure safe and trouble-free operation of your balance:

- ⚠ Do not use this balance in a hazardous area/location
- ⚠ Make sure that the voltage rating printed on the AC adapter is identical to your local line voltage
- The only way to switch the power off completely is to disconnect the AC adapter
- The balance housing is IP54-protected against harmful dust deposits and water splashes – the housing is not completely dust-tight, however
- Protect the AC adapter from contact with liquid
- Connect only Sartorius accessories and options, as these are optimally designed for use with your Master<sup>PRO</sup> balance

When cleaning your balance, make sure that no liquid enters the balance housing; use only a slightly moistened cloth to clean the balance.

Do not open the balance housing. If the seal is broken, this will result in forfeiture of all claims under the manufacturer's warranty.

In case you have any problems with your balance:

- contact your local Sartorius office, dealer or service center

## Operating Design

The balances in the Master<sup>pro</sup> Series consist of a weighing cell and a display and control unit. In addition to the choice of power supply (via AC adapter or external rechargeable battery pack), your balance also has an interface port for connecting a printer, computer or universal remote control switch.

The display and control unit and the weighing cell can be set up separately. Operation of Master<sup>pro</sup> balances follows a uniform "philosophy" which is described in this manual.

## Keys

The functions used most often are assigned to their own specific keys. There are additional keys for assignment of other (multiple) functions, in some cases dependent on the current operating status (so-called "soft keys").

Each key is described in detail in the chapter entitled "Overview."

## Normal Operation

In the operating mode, these four keys function as [CF], [CAL], [↶] and [F] keys.



## Setup Mode

In the setup mode, these keys take on the function of arrow keys ([<], [v], [^], [>]).



## Soft Key Mode

The 'soft key' functions depend on the current operating status; the current function is indicated in the text line of the display. In this example, the soft keys are used to access Info, Menu and Input functions.



## Display

The display is divided into six sections:

Line for metrological data	
Bar graph	Weight unit display
Measured value line	
Symbol display	Text line

- Line for metrological data: Metrological specifications of the weighing platform.  
Max ...g d=...g  
Display during use as a legal measuring instrument:  
Max ...g Min ...g e=...g d=...g
- Bar graph: Display in percent of the weight on the balance relative to the maximum capacity and for over/under checkweighing
- Measured value line: Display of weight readout or alphanumeric input

### Important Note Concerning Verified Balances Approved for Use as Legal Measuring Instruments in the EU\*:

For verified balances that have a verification scale interval "e" which is greater than the scale interval "d," the last digit on the display is bordered.

- Weight unit display: Weight unit, other unit of measure, operating information

The  symbol indicates non-verified weight values.

- Symbol display: Indicates operating status; application selected
- Text line: Prompts for operator guidance, soft key designations

See the "Data Output" section in the chapter entitled "Operating the Balance" for a detailed description of the information displayed in each of these sections.

\* including the Signatories of the Agreement on the European Economic Area

## Input

### Numeric Input

To enter numbers:

Press the **1** **2** ... **0** **.** keys

To store numbers entered:

Press the soft key

To interrupt/cancel numeric input:

Press **CF**

### Alphabetic Input

To enter letters:

First press the **ABC** key, then press a letter soft key (**^** or **v**) repeatedly until the desired letter or special character is displayed in the text line

To store a word entered:

Press the soft key

To interrupt/cancel alphabetic input:

Press **CF**

### Configuring Balance Operating Parameters

To set parameter options for configuring your balance, you can select the desired parameters from a list. The lists of parameter options comprise a menu, which has three levels.

For configuration functions:

Press the **SETUP** key; then press the **MENU** soft key

To move within a menu level:

Press **^** or **v**

To change to another menu level:

Press **<** or **>**

To confirm the selected parameter setting in the 3rd menu level:

Press **>**

"o" indicates the currently set parameter

Additional information is displayed in the text line. See the chapter entitled "Configuring the Balance" for a detailed description of all parameter settings.

To save setting and exit menu:

Press **SETUP**

To interrupt the parameter setting process without saving changes:

Press **OFF**

### Data Output

Your Master<sup>PRO</sup> balance is equipped with a data interface for connecting your choice of the following:

- Printer
- Peripheral device (e.g., computer)
- Universal remote control switch

#### Printer

You can configure the print functions to meet your individual requirements by selecting the corresponding menu code.

You can have printouts generated automatically, or by pressing **Q**; dependent on or independent of the stability or time parameters; with or without IDs; and as standard or ISO/GLP-compliant printouts.

ISO: International Organization for Standardization

GLP: Good Laboratory Practice

See the section on "Data Output Functions" in the chapter entitled "Operating the Balance" for a detailed description of data output options.

### Interface Port

Instead of a printer, you may choose to connect a different peripheral device, e.g. a computer (PC). With an on-line PC you can control both the weighing cell and the display unit of the Master<sup>PRO</sup> balance.

Request messages are sent via the interface to initiate functions in the weighing cell and in the display unit. Some of the functions generate response messages.

See the section on "Data Output Functions" in the chapter entitled "Operating the Balance" for a detailed description of the interface port.

### Error Codes

If you press a key that has no function, or which is blocked at a certain point in an application program, this error is indicated as follows:

- a double-beep is sounded as an acoustic signal, and
- where necessary, a message is displayed for 2 seconds in the text line, after which the text line returns to the previous display.

The response to an operator error is identical in all models of the Master<sup>PRO</sup> series. See the chapter entitled "Error Codes" for a detailed description.

### Storing Settings

#### Storing Parameter Settings

The settings configured are stored in the balance's non-volatile memory. The most recent parameter settings are active when you switch on the balance.

#### Saving Parameter Settings

You can assign passwords in order to block access to the "Menu" and "Input" functions.

## Getting Started

### Warranty

Do not miss out on the benefits of our full warranty. Complete the warranty registration card, indicating the date of installation, and return the card to your Sartorius office or dealer.

### Storage and Shipping Conditions

Allowable storage temperature:  
0 °C ...+40 °C (+32°F ...+104°F)

The packaging has been designed to ensure that the balance will not be damaged even if it is dropped from a height of 80 centimeters (about 31 inches). Do not expose the balance to extreme temperatures, blows, shocks, vibration or moisture.

### Unpacking the Balance

- After unpacking the balance, check it immediately for any visible damage as a result of rough handling during shipment.
- If this is the case, proceed as directed in the section on "Safety Inspection" in the chapter entitled "Care and Maintenance."

It is a good idea to save the box and all parts of the packaging until you have successfully installed your balance. Only the original packaging provides the best protection for shipment. Before packing your balance, unplug all connected cables to prevent damage. The cardboard strips between the display and control unit and the weighing platform are part of the protective packaging for shipment!

#### Important Note Concerning Verified Balances Approved for Use as Legal Measuring Instruments in the EU\*:

Provided that an official seal is required for the verified balance, a control seal is affixed to the balance. This seal will be irreparably damaged if you attempt to remove it. If the seal is broken, the validity of the verification will become void, and you must have your balance re-verified.

### Equipment Supplied

The equipment supplied includes the components listed below:

#### LP balances with a readability of 1 mg

- Balance with display and control unit
- AC adapter
- Dust cover
- Shield disk
- Pan support
- Weighing pan
- Glass draft shield cylinder
- Draft shield cover

#### LP8200S, LP8200P, LP 6200S, LP 4200S, LP 2200S, LP 820, LP 420, LP 2200P, LP 5200P

- Balance with display and control unit
- AC adapter
- Dust cover
- Pan draft shield
- Weighing pan

#### LP 12000S, LP 6200, LP 4200, LP 2200, LP 12000P

- Balance with display and control unit
- AC adapter
- Dust cover
- Weighing pan

\* including the Signatories of the Agreement on the European Economic Area

#### LP 16000S, LP 34000P, LP 34

- Balance with display and control unit
- AC adapter
- Weighing pan

### Installation Instructions

The Sartorius Master<sup>PRO</sup> balances are designed to provide reliable weighing results under normal ambient conditions in the laboratory and in industry. When choosing a location to set up your balance, observe the following so that you will be able to work with added speed and accuracy:

- Set up the balance on a stable, even surface
- Avoid placing the balance in close proximity to a heater or otherwise exposing the balance to heat or direct sunlight
- Protect the balance from drafts that come from open windows or doors
- Avoid exposing the balance to extreme vibrations during weighing
- Protect the balance from aggressive chemical vapors
- Do not expose the balance to extreme moisture

### Conditioning the Balance

Moisture in the air can condense on the surfaces of a cold balance whenever it is brought into a substantially warmer place. If you transfer the balance to a warmer area, make sure to condition it for about 2 hours at room temperature, leaving it unplugged from AC power. Afterwards, if you keep the balance connected to AC power, the continuous positive difference in temperature between the inside of the balance and the outside will practically rule out the effects of moisture condensation.

## Setting Up the Balance

### Preparing Balances with a Round Glass Draft Shield

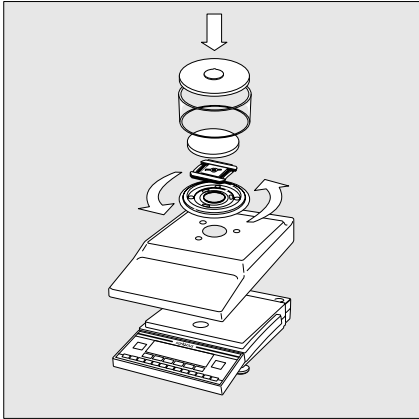

● Place the components listed below on the balance in the order given:

- Dust cover
- Shield disk; turn counter-clockwise until it stops and is secured
- Pan support
- Weighing pan
- Glass draft shield cylinder
- Draft shield cover

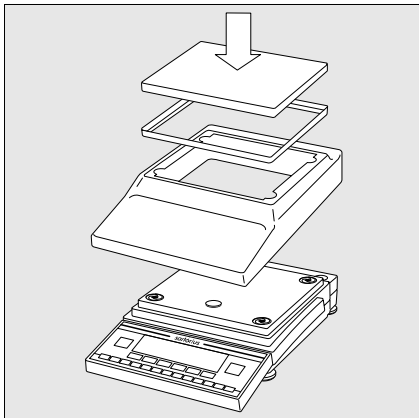

### Preparing Balances with a Rectangular Weighing Pan and a Weighing Capacity $\leq 12$ kg

● Place the components listed below on the balance in the order given:

- Dust cover
- Pan draft shield (depending on the model)
- Weighing pan

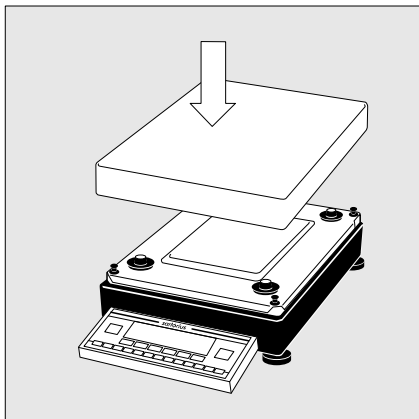

### Preparing Balances with a Rectangular Weighing Pan and a Weighing Capacity $\geq 16$ kg

● Place the weighing pan on the balance

## Separate Operation of the Display Unit

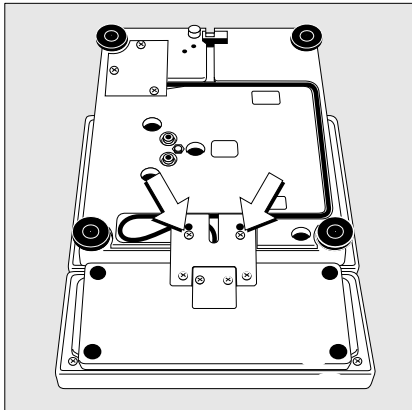

- Turn the balance upside down and lay it on a padded surface to avoid damage to the weighing system.
- Use a screwdriver to remove the 2 screws from the display unit retainer
- Remove the display unit
- > Cable lengths
  - LP balances with a weighing capacity  $\leq 12$  kg: 55 cm
  - LP balances with a weighing capacity  $\geq 16$  kg: 80 cm
- See the chapter entitled "Accessories" for information on longer cables
- If you wish to use a longer cable, it must be installed by an authorized Sartorius service technician

## Options for Mounting the Display Unit for the LP 16000S, LP 34000P, LP 34

The display unit can be mounted as follows:

- on the short side of the weighing cell (factory mounting)
- on the back (long side) of the weighing cell

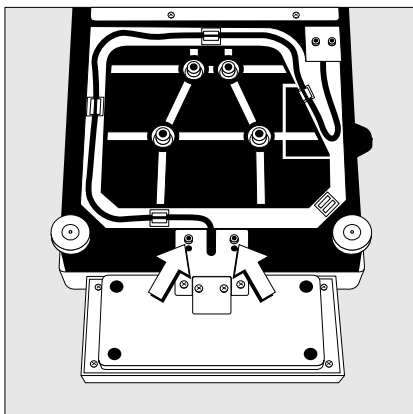

- Turn the weighing cell over
- Use an Allen wrench to remove the fastening screws from the display unit retainer

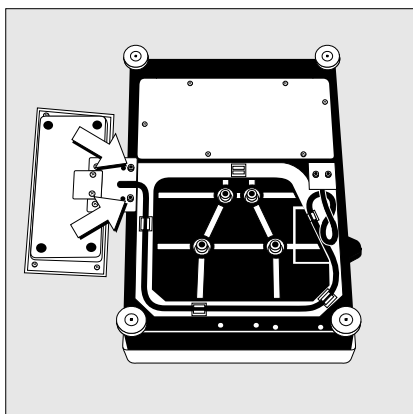

- Remove the cable from the raceway (channel)
- Fasten the display unit retainer onto the back of the weighing cell with the 2 Allen screws
- Thread the cable through the raceway as shown in the diagram on the left

## Connecting the Balance to AC Power

- Check the voltage rating and the plug design
  - If they do not match the rating or standard you use, contact your Sartorius office or dealer

Use only

- Original Sartorius AC adapters
- AC adapters with a registered approval rating from a national testing laboratory
- To use a main feeder cable from the ceiling or to mount a CEE plug, you will have to make arrangements inside your facilities to have this equipment installed
- See the “Accessories” for information on using an IP65-protected industrial AC adapter or an external rechargeable battery pack with your balance

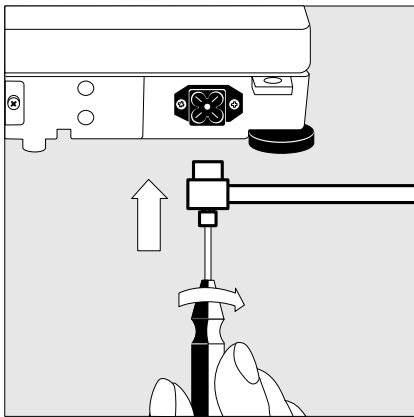

- Insert the right-angle plug into the jack and tighten the screws
- Then plug the AC adapter into a wall outlet (mains)

### Safety Precautions

The AC adapter rated to Class 2 can be plugged into any wall outlet without requiring any additional safety precautions. The ground or earth terminal is connected to the balance housing, which can be additionally grounded, if required. The data interface is also electrically connected to the balance housing (ground).

### Information on Radio Frequency Interference

#### Warning!

This equipment generates, uses and can radiate radio frequency energy and, if not installed and used in accordance with the instruction manual, may cause interference to radio communications. It has been tested and found to comply with the limits for a Class A computing device pursuant to Subpart J of Part 15 of FCC Rules, which are designed to provide reasonable protection against such interference, when operated in a commercial environment. Operation of this equipment in a residential area is likely to cause interference, in which case the user, at his own expense, will be required to take whatever measures may be required to correct the interference.

### Connecting Electronic Peripheral Devices

- Make absolutely sure to unplug the balance from AC power before you connect or disconnect a peripheral device (printer or PC) to or from the interface port.

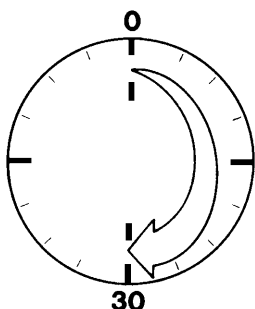
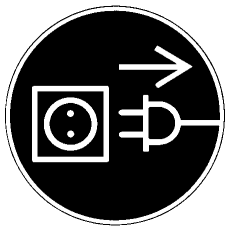

### Warmup Time

To deliver exact results, the balance must warm up for at least 30 minutes after initial connection to AC power or after a relatively long power outage. Only after this time will the balance have reached the required operating temperature.

### Using Verified Balances as Legal Measuring Instruments in the EU\*

The balance must warm up for at least 24 hours after initial connection to AC power.

\* including the Signatories of the Agreement on the European Economic Area



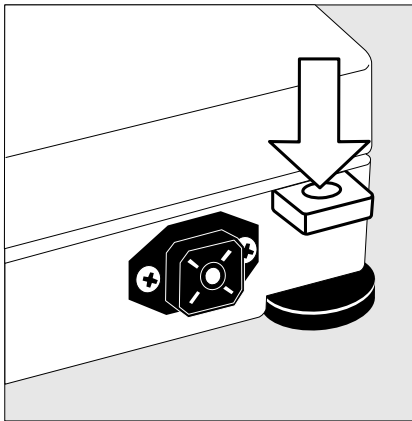

## Fastening an Antitheft Locking Device: Balances with a Weighing Capacity of 12 kg

To fasten an antitheft locking device, use the lug located on the rear panel of the balance.

- Secure the balance at the place of installation, e.g., with a chain or a lock.

## Leveling the Balance

Purpose:

- To compensate for unevenness at the place of installation
- To achieve perfectly horizontal positioning of the balance for consistent reproducibility

Always level the balance again any time after it has been moved.

### Leveling Balances with a Weighing Capacity $\leq 12$ kg

Only the 2 front feet are used for leveling.

- Retract the 2 rear feet
- Turn the 2 front feet as shown in the diagram until the air bubble is centered within the circle of the level indicator
- > Several leveling steps are usually required.
- For weighing heavy samples:  
Extend the 2 rear feet until they touch the surface on which the balance rests

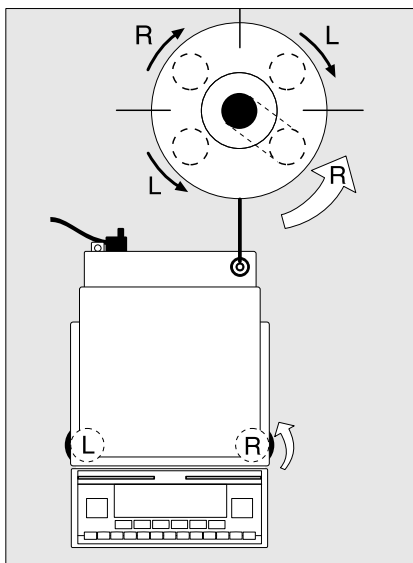

### Leveling Balances with a Weighing Capacity $\geq 16$ kg

- Adjust the three leveling feet until the air bubble is centered within the circle of the level indicator

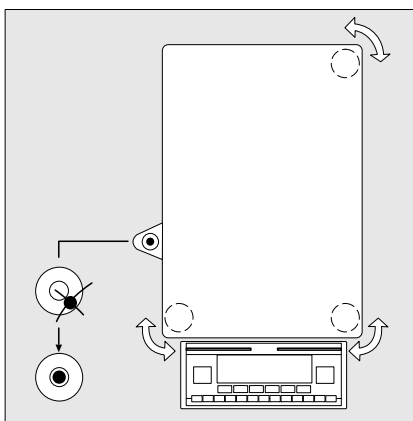

## Configuring the Balance

### Purpose

You can configure your Master<sup>PRO</sup> balance to meet individual requirements by entering user data and setting parameters in the Setup menu. You can also configure the display to show balance-specific information (such as the serial no.).

### Setting the Function Switch for Using the Balance in Legal Metrology

To use the balance in legal metrology, the following functions must be activated by setting the switch as described below:

- Display: Verification scale interval **e**; lower weighing range limit: **Min**
- External calibration/adjustment: Blocked
- MP8 interface emulation active

### Preparation

- Remove the covering plate from the back of the balance housing
- Move switch 1 in the direction of the arrow

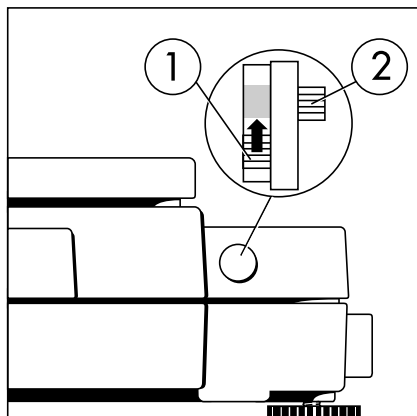

- > Switch up:  
external calibration blocked
- Switch down:  
external calibration accessible

- > Note:  
Do not move Switch 2

## Setting the Language

### Available Features

You can choose from 5 languages for the information display:

- 1 German
- 2 English (factory setting)
- 3 English with U.S. date/time format
- 4 French
- 5 Italian
- 6 Spanish

### Selecting the Language

- Enter the corresponding number
- Press **SETUP**

## 'Info' Display

### Purpose

To have information about the equipment displayed.

### Features

You can have the following information displayed:

- Program version number for the display and control unit
- Program version for the weighing cell
- Balance model
- Serial number of the weighing cell

### Display Balance Information

- Select the Setup menu:  
Press **SETUP**
- Select information:  
Press the **INFO** soft key **CAL**
  - > Readout in measured value line:  
Version number of the display and control unit (see also "Data Output Functions," pages 56–57, in the chapter entitled "Operating the Balance")
  - Select next item of information:  
Press **▲**
  - > Readout in measured value line:  
Next information
  - Select previous information:  
Press **▼**
  - > Readout in measured value line:  
Previous information
  - Print information: Press **Ⓞ**
  - > Printout (example)  

<b>Mod.</b>	<b>LP6200S</b>
<b>Ser. no.</b>	<b>60406906</b>
<b>Ver. no.</b>	<b>01-30-13</b>

Software version  
(display and control unit)  
**Ver. no.** **00-20-07**  
Software version  
(weighing platform)
- Exit the Setup menu:  
Press **SETUP**
  - > Balance returns to previous status

## Entering User Data (Input)

### Purpose

To display, input or change user data. You can block access to these data by assigning a password.

### Features

You can display, input or change the following user data:

- Workstation number\* for the balance: ID (balance ID; max. 20 characters)\*\*
- Weighing series number, to designate a series or lot: L ID (lot ID; max. 20 characters)\*\*
- Weight set number for calibration/adjustment: W ID (weight ID; max. 14 characters)\*\*
- Exact weight value for calibration/adjustment of the balance (see the section on “Calibration/Adjustment,” starting on page 24 in the chapter entitled “Operating the Balance; in particular refer to page 27)
- Password for access to the Setup menu: Input and Setup: Menu (max. 8 characters)\*\*

\* Only in conjunction with ISO/GLP-compliant printouts (see the section on “Setting Parameters” in the chapter entitled “Configuring the Balance;” under menu code number 8 10 x).

\*\* A decimal point is displayed together with its preceding digit or character; it does, however, count as a separate character. This also applies when you enter S ID and NUM as well as to data entered via the interface.

\*\*\* To delete user password: Enter a decimal point using the  key and confirm

## Factory Settings

Password: No designation

If no password has been assigned, anyone can access the “Setup: Input” and “Setup: Menu” functions without entering a password.

If you assign a password and then forget what the word is, you can use the General Password (see Appendix) to access these menus.

### Preparation

Display existing user data





- Select the Setup program: Press
- > The soft keys *INFO*, *MENU* and *INPUT* are displayed in the text line
- Select the user data input function: Press the *INPUT* softkey
- > The password prompt is displayed
- If access is blocked by a password: enter the password using the alphanumeric input keys
- Display user data: Press the *ENTER PASSW.* soft key
- > The last 8 digits of a workstation/balance number (ID no.), if any ID is assigned, are displayed in the measured value line





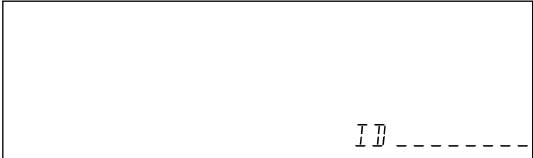
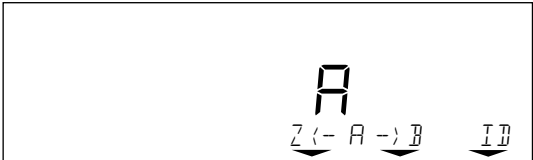



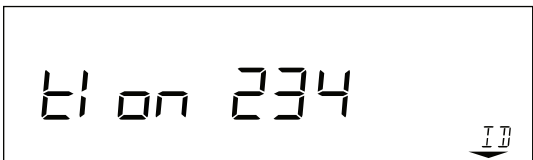
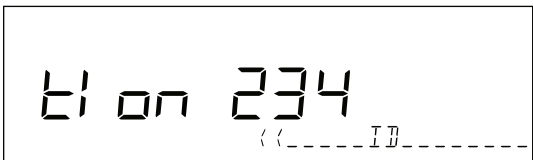
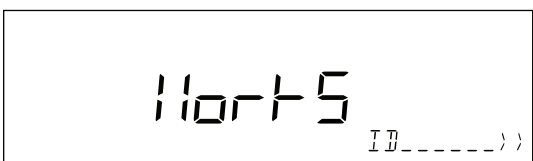

## Enter/Change Password

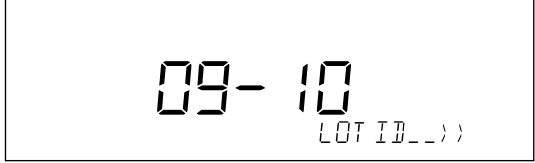
- Select the Setup menu: Press
- > The soft keys *INFO*, *MENU* and *INPUT* are displayed in the text line
- Select the user data input function: Press the *INPUT* soft key
- If you have already assigned a password:
  - > The password prompt is displayed
  - Enter the password
  - Press the *ENTER PASSW.* soft key
  - Write down the password here: Password = .....
  - If you no longer remember the password assigned:
    - Enter the General Password (see Appendix)
    - Press the *ENTER PASSW.* soft key
    - > The last 8 digits of a workstation/balance number (ID no.), if any ID is assigned, are displayed in the measured value line
  - Select password setting: Press
  - > *PASSWORD* is displayed in the text line
  - > If a password exists, it is now displayed in the measured value line
  - New password: Enter the letters/numbers for the new password (8 characters max.)\*\*
  - The password “none” means that no password is stored.\*\*\*
  - Confirm input: Press
  - Exit the Setup menu: Press
  - > Restart the application

## Practical Example

Enter "Workstation 234" as Balance ID; Display and Print Other User Data

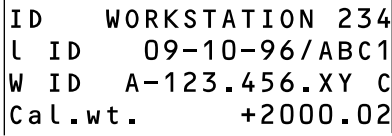
Step	Key (or instruction)	Display/Output
1. Select Setup menu, then Input; Display balance workstation ID (in this example: no ID number exists)	see Preparation	
2. Enter the first letter of the balance workstation ID	<b>ABC</b>	13th through 20th digits of ID displayed 
3. Set the letter "W"	<b>▼</b> repeatedly, until the <i>w</i> is in the middle	
4. Enter the next letter of the balance workstation ID	<b>ABC</b>	
5. Select the letter "o"	<b>▲</b> repeatedly	
6. Repeat steps 4 and 5 with the appropriate letters (display "longer" values: see "Data Output Functions" on page 57)	<b>ABC</b> <b>&lt;</b> <b>&gt;</b>	
7. Store balance workstation ID	<b>ID</b> soft key ( <b>&gt;</b> )	
8. Display the 5th through 12th digits of the balance workstation ID	<b>&lt;</b>	

Step	Key (or instruction)	Display/Output
9. Display lot number (In this example: 09-10-96/ABC1)		13th through 20th digits displayed 
10. Display 5th through 12th digits of lot no.		
11. Display other user data – Weight set no. – Exact calibration weight – Password	   	
12. Print user data (example)		
13. Exit "Setup: Input"		

## Setting Parameters (Menu)

### Purpose

To configure the balance; i.e., adapt the balance to individual requirements by choosing from a list of parameter options in a menu. You can block access to this menu by assigning a password.

### Features

The parameter options are divided into the following groups (1st menu level):

- 1 Balance functions
- 2 Application programs
- 3 Application parameters
- 4 +/- parameter (for over/under checkweighing)
- 5 Interface parameters
- 6 Print for weighing (print weights)
- 7 Print for application program (print app. data)
- 8 Additional functions
- 9 Reset menu

### Factory Settings

The factory-set configurations are marked with an "o" in the list starting on page 16

### Preparation





- Select the Setup menu:  
Press **SETUP**
- > The *INFO*, *MENU* and *INPUT* soft keys are displayed in the text line
- Select the parameter menu:  
*MENU* soft key **S**
- > Password prompt is displayed
- Enter password using the alphanumeric input keys
- Confirm password entered:  
*ENTER PASSW.* soft key **F**
- > Measured value line:  
1 (1st menu level)
- > Text line: *BALANCE FUNCTIONS*
- Select the next group: Press **^**
- Select the next submenu within a group (2nd menu level):  
Press **>**
- Select previous group: Press **v**
- Return to next higher menu level:  
Press **<**

### Additional Functions

- Exit the menu: Press **SETUP**
- > Restart the application
- Print parameter settings:
  - When the 3rd menu level is selected: Press **@**
  - > Printout (example)  
**4 2 Auto print +/-**  
**2 Off**
  - When the 2nd menu level is selected: Press **@**
  - > Printout (example)  
**4 Parameter +/-**  
-----  
**4 2 Auto print +/-**  
**2 Off**  
**4 3 +/- ctrl ports**  
**1 Within ctrl r**
  - When the 1st menu level is displayed: Press **@**
  - > Prints all of the menu parameters that are currently set

## Practical Example

Select the Counting Application Program

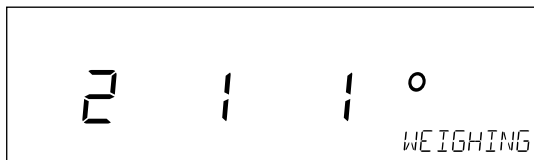
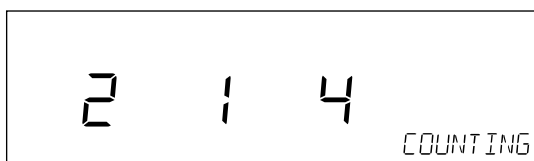
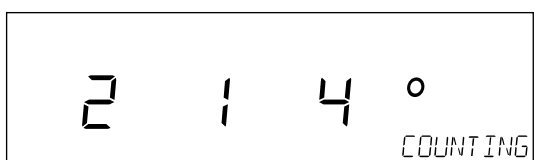
Step	Key (or instruction)	Display/Output
1. Select Setup menu	<b>SETUP</b>	
2. Select Balance Functions group code (Menu)	<i>MENU</i> soft key <b>5</b>	
3. Select the Application Prog. group	<b>^</b>	
4. Confirm Application Program (2nd menu level)	<b>&gt;</b>	
5. Confirm App. Selection (3rd menu level shows current setting; in this case: weighing)	<b>&gt;</b>	
6. Select the Counting program	<b>^</b> <b>^</b>	
7. Confirm selection of Counting program	<b>&gt;</b>	
8. Set other parameters, if desired	<b>&lt;</b> <b>v</b> <b>^</b> <b>&gt;</b>	
9. Save settings and exit menu	<b>SETUP</b>	

## Setup Parameters (Overview)

- Factory setting
- √ User setting

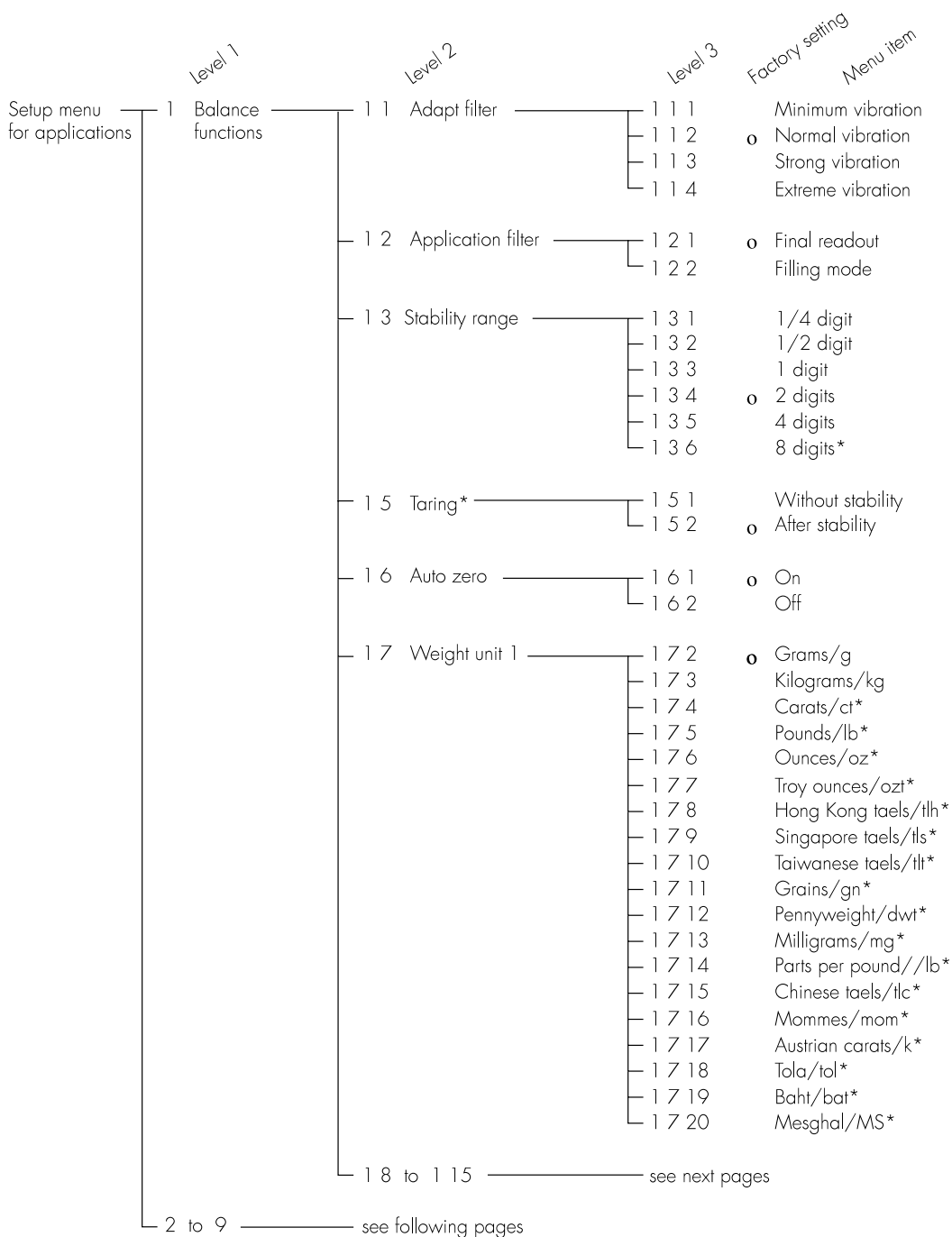

\* = setting not applicable in balances verified for use in legal metrology  
 \*\* = not in balance model LP34-OCE



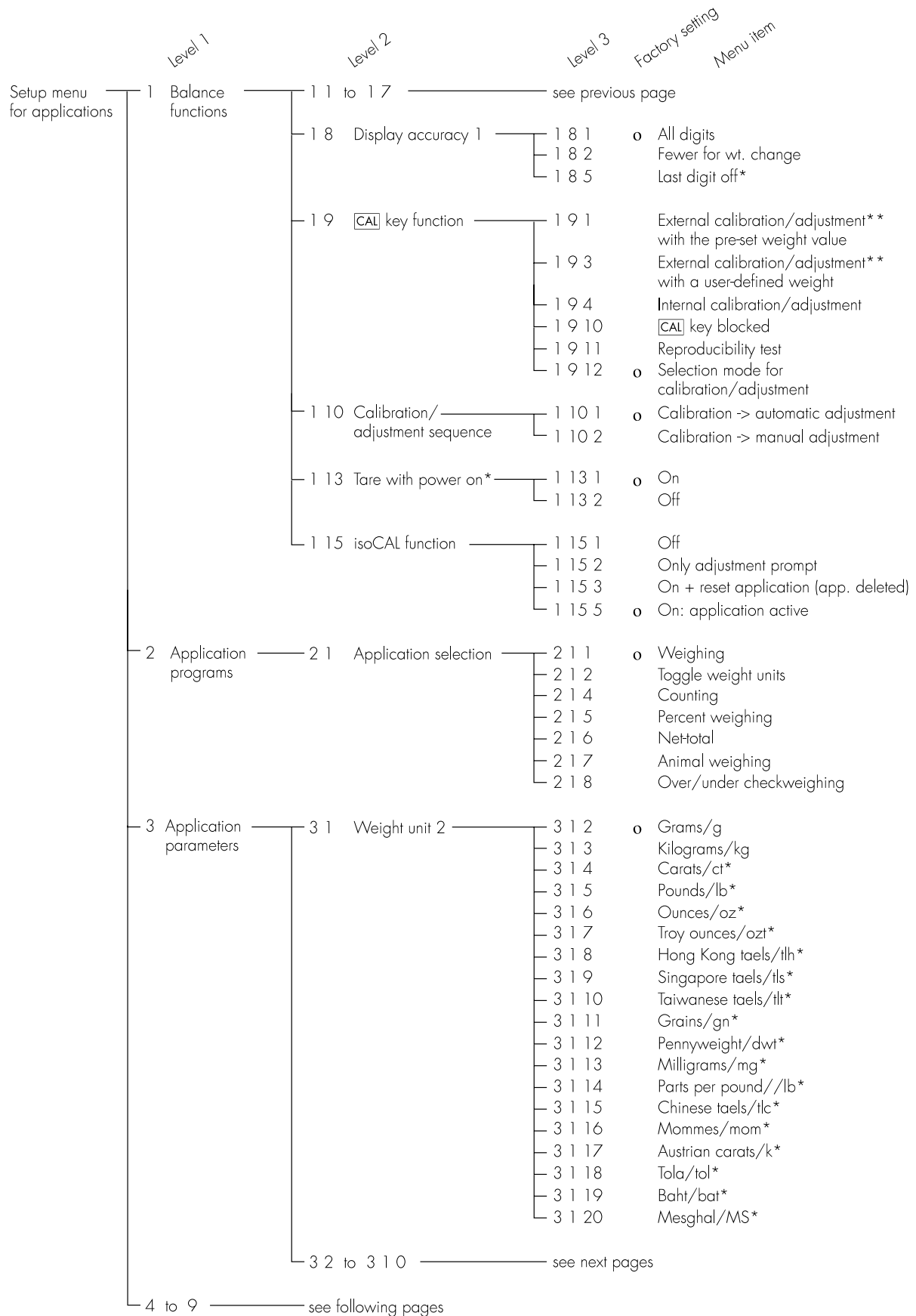

\* = setting not applicable in balances verified for use in legal metrology

\*\* = not in balance model LP34-OCE

\*\*\* = for balances of accuracy class **II**, only calibration (not adjustment) can be performed with a user-defined weight

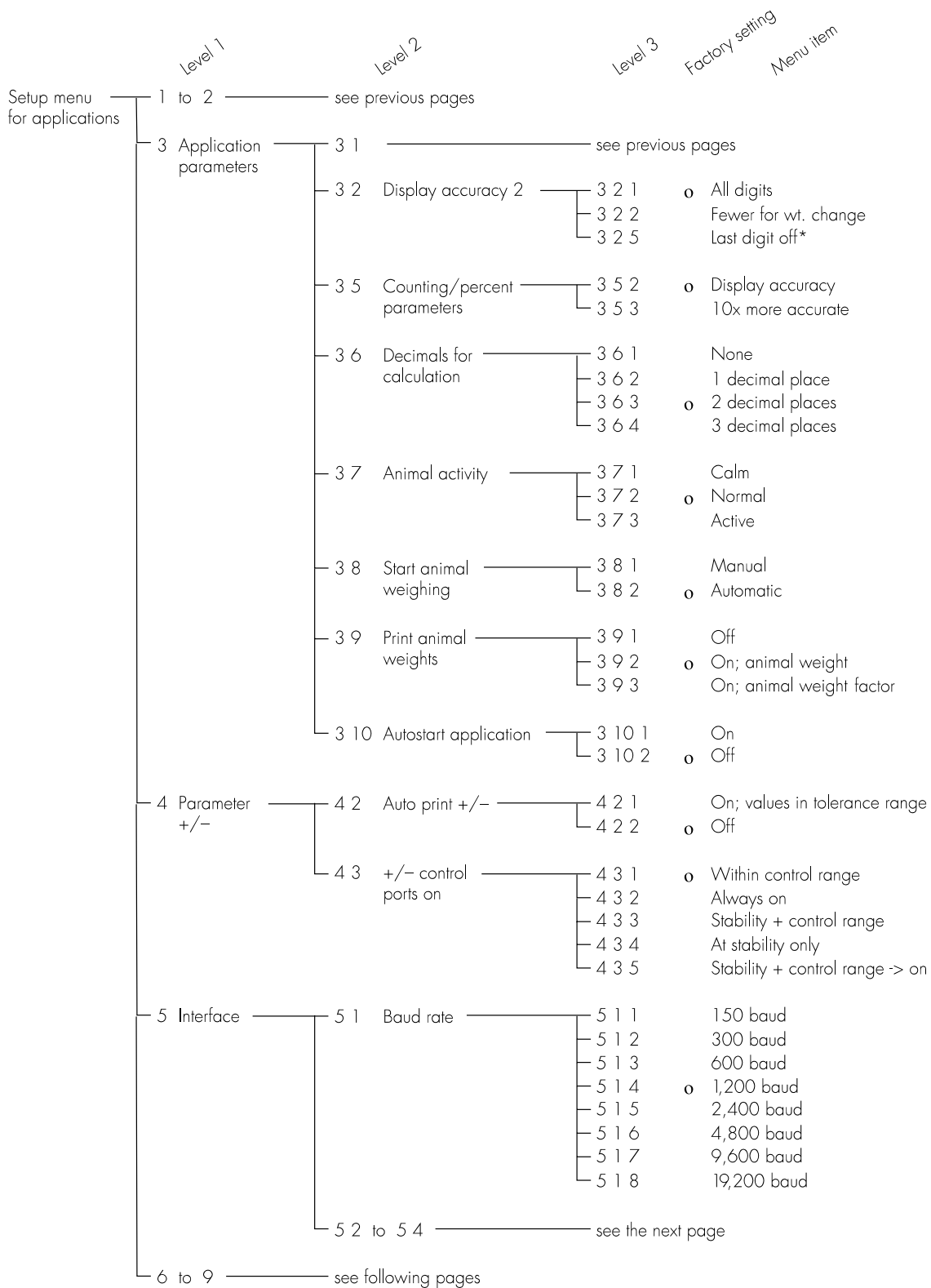

\* = setting not applicable in balances verified for use in legal metrology

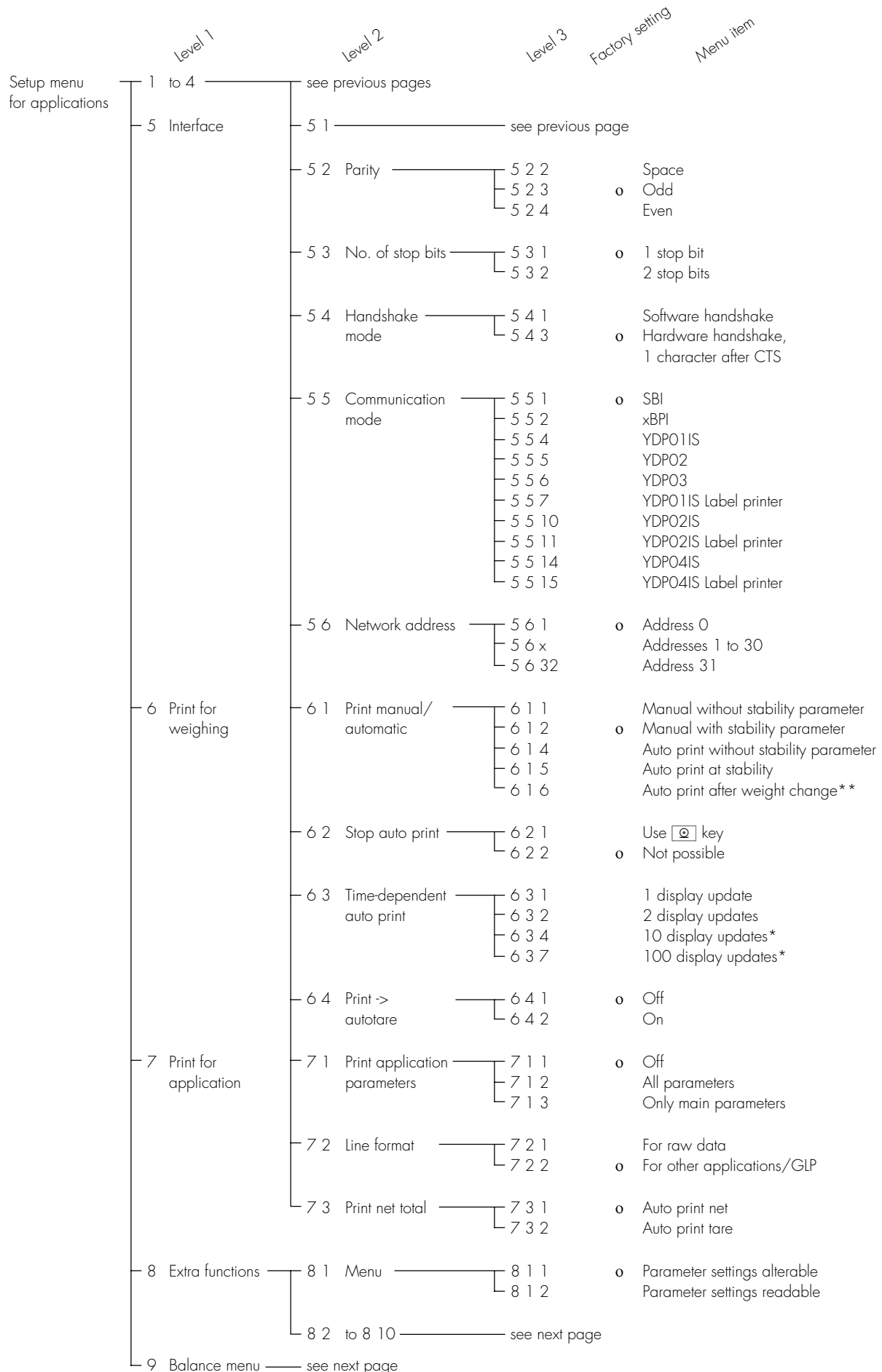

\* = setting not applicable in balances verified for use in legal metrology

\*\* = Auto print if change in weight >10 d and has stable readout; function enabled when load <5 d

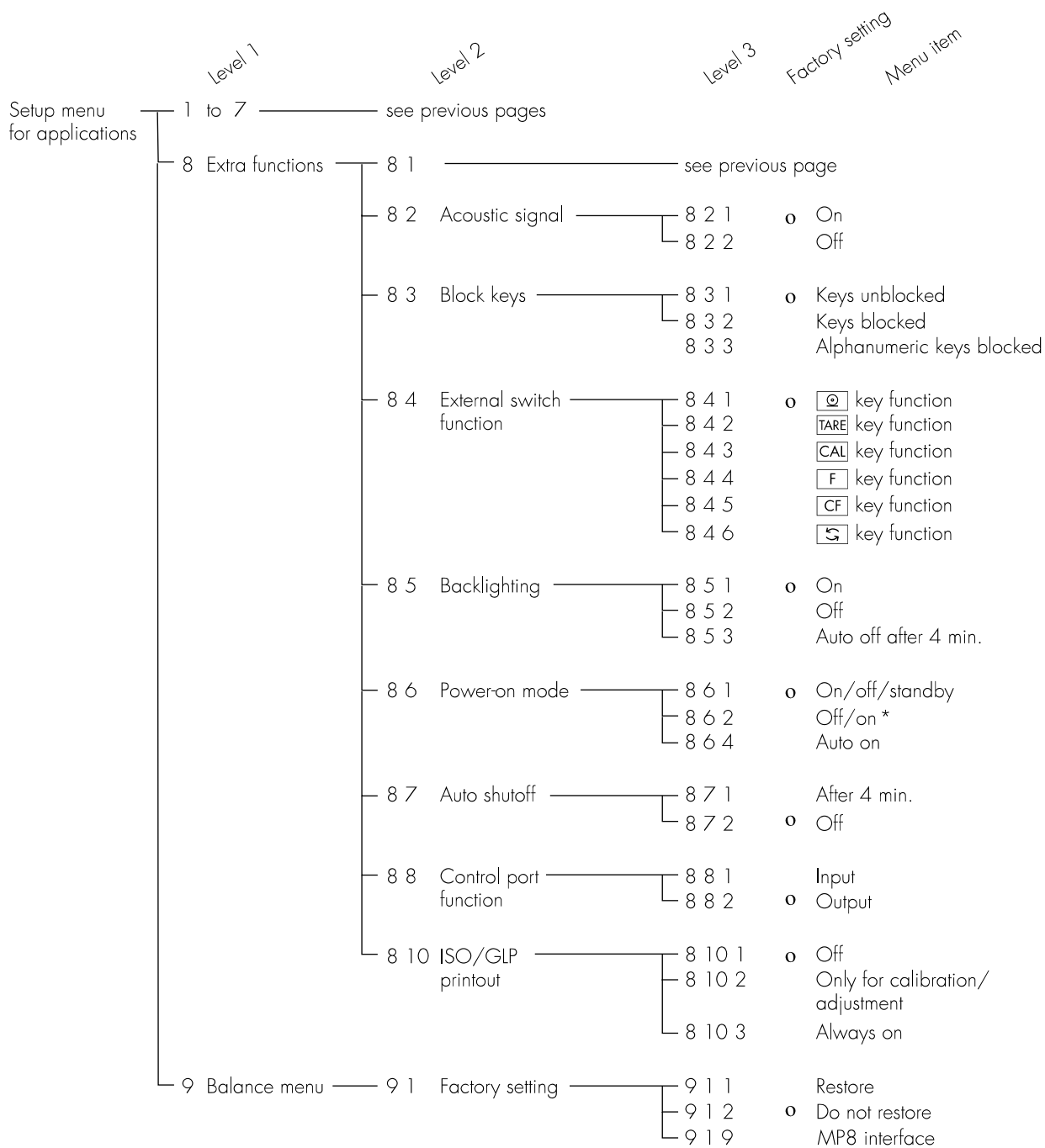

\* = not in balance models with a weighing capacity  $\geq 16$  kg.

## Operating the Balance

### Basic Weighing Function

#### Purpose

The basic weighing function is always accessible and can be used alone or in combination with an application program (Toggle between Weight Units, Counting, Weighing in Percent, etc.).

#### Features

- Taring the balance
- Assigning IDs to weights
- Printing weights
- Printing ID codes for weights

#### Factory Settings

Tare: After stability ( **1 5 2** )

Print manual/automatic:  
Manual after stability ( **6 1 2** )

Line format for printout:  
For other applications/GLP ( **7 2 2** )

Alphanumeric input of a weight ID:  
Keys unblocked ( **8 3 1** )

### Below-Balance Weighing

A port for a below-balance weighing hanger is located on the bottom of the balance (for balances with a weighing capacity > 12 kg, see the "Accessories" in the chapter entitled "Overview").

- Open cover plate (1) on the bottom of the balance

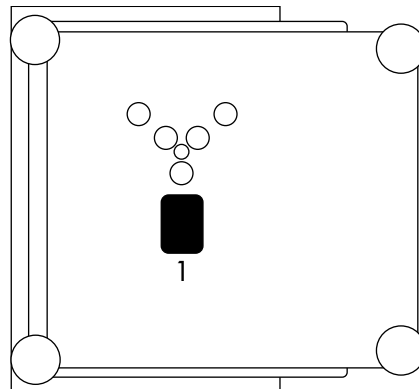

- Attach the sample (e.g., using a suspension wire) to the hook (2).

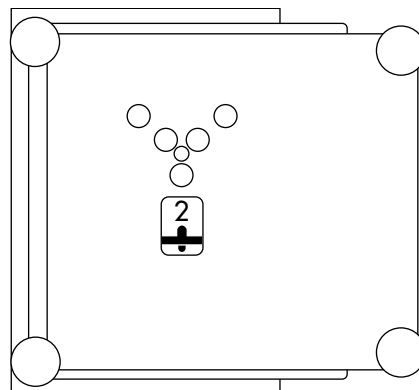

- If necessary, install a shield for protection against drafts

#### Important Note Concerning Verified Balances Approved for Use as Legal Measuring Instruments in the EU\*:

The below-balance weighing port may not be opened or used when an approved balance is being operated as a legal measuring instrument.

### Preparation

- Turn on the balance: Press **I/O**
- > All display segments light up briefly
- To change configurations: see the chapter entitled "Configuring the Balance"
- To load factory-set configurations: see "Configuring the Balance," parameter **9 1**
- To tare the balance: Press **TARE**
- > The **→0←** symbol is displayed when the balance is zeroed or tared (only on balances verified for use in legal metrology)

#### Using Verified Balances Approved for Use as Legal Measuring Instruments in the EU\*:

This balance is not allowed to be used for weighing goods intended for direct sale to the public. The type-approval certificate for verification applies only to non-automatic weighing instruments; for automatic operation with or without auxiliary measuring devices, you must comply with the regulations of your country applicable to the place of installation of your balance.

- You must calibrate the balance at the place of installation before using it as a legal measuring instrument (see the section entitled "Calibration/Adjustment" in this chapter)
- The temperature range indicated on the verification ID label must not be exceeded during operation

Example:  
MD BF 100  
**I** +15 °C./.+25 °C

\* including the Signatories of the Agreement on the European Economic Area

ID for weight value (if desired):

- Select the parameters "Line format" and "For other app./GLP" from the Setup menu: Press **SETUP**
- Select mode:  
Press the **MENU** soft key
- Set parameter **7 2 2**: See the chapter entitled "Configuring the Balance"
- Exit the Setup menu:  
Press **SETUP**

### Additional Functions

In addition to the functions:

- alphanumeric input,
- taring  
(not during alphanumeric input),
- printing,

you can also access the following functions from the weighing application:

- calibration  
(not during alphanumeric input),
- setup,
- turning off the balance.

### Calibration

- Press **CAL**
- > See the section on "Calibration/Adjustment" for further instructions.

### Setup Menu

- Press **SETUP**
- > See the chapter entitled "Configuring the Balance" for further instructions.

### Turning Off the Balance

- Press **OFF**
- > The balance shuts off
- > The display goes blank

### Important Note Concerning Verified Balances of Accuracy Class **I**:



To avoid measuring errors, the respective air density must be allowed for. The following formula is used to calculate the mass of the sample:

$$m = n_w \frac{1 - \rho_L / 8000 \text{ kg m}^{-3}}{1 - \rho_L / \rho}$$

$m$  = mass of the sample  
 $n_w$  = weight readout  
 $\rho_L$  = air density during weighing  
 $\rho$  = density of the sample

## Practical Examples

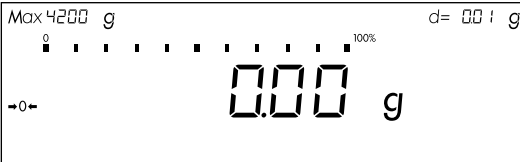
### Example W1: Simple Weighing

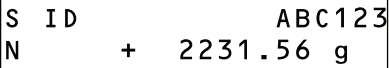
Step	Key (or instruction)	Display/Output
1. If necessary, tare the balance ( <b>→0←</b> symbol: balance is tared, - verified balances only)	<b>TARE</b>	
2. Enter sample ID	see Example W2	
3. Determine sample weight (Example)	Place sample on balance	
4. Print weight	<b>PRINT</b>	

## Example W2

Enter "ABC123" as a sample ID

Note:

- The sample ID generally applies to one weighing operation only
- The ID is deleted after data output

Step	Key (or instruction)	Display/Output
Initial status (balance unloaded) (ID can also be entered while balance is loaded)		
1. Enter the letter "A"	<b>ABC</b>	
2. Select and enter the letter "B"	<b>ABC</b>	
	Softkey <b>B</b> (Key <b>↵</b> )	
3. Select and enter the letter "C"	<b>ABC</b> Softkey <b>C</b> (Key <b>↵</b> <b>↵</b> )	
4. Enter the numbers "1," "2" and "3"	<b>1</b> <b>2</b> <b>3</b>	
5. Store the ID (max. 20 characters)	Press the <b>SP.ID</b> soft key <b>F</b>	

- The next printout will include this ID

## Calibration/Adjustment

### Purpose

Calibration is the determination of the difference between the weight readout and the true weight (mass) of a sample. Calibration does not entail making any changes within the balance.

Adjustment is the correction of this difference between the measured value displayed and the true weight (mass) of the sample, or the reduction the difference to an allowable level within the maximum permissible error limits.

### Using Verified Balances as Legal Measuring Instruments in the EU\*:

Before using your balance as a legal measuring instrument, you must perform "internal calibration" at the place of installation after the warmup period.

### Available Features

Your balance can be calibrated externally (menu item 1 9 1 or 1 9 3) or internally (1 9 4).

External calibration can be performed

- with the pre-set weight value (1 9 1), or
- with a user-defined weight value (1 9 3)

Adjustment can be performed

- automatically following calibration (1 10 1); or
- if desired, the adjustment operation can be started manually after calibration (1 10 2)

You can also configure whether the calibration mode

- will be activated according to the specific setting (by setting 1 9 1, 1 9 3 or 1 9 4), or
- can be selected by the user after pressing the **CAL** key (1 9 12).

You can have the balance automatically display an adjustment prompt after a certain time interval has elapsed since the last calibration/adjustment or when the ambient temperature changes by a defined amount.

You can also configure the balance to perform calibration and adjustment automatically (isoCAL) when the pre-set time and/or temperature limit is reached (1 15 3 and 1 15 5).

You can have the calibration/adjustment results documented in a ISO/GLP-compliant printout.

### Releasing Access to External Calibration in Verified Balances of Accuracy Class 1

- Remove the covering plate from the back of the balance housing
  - Move Switch 1 in the direction of the arrow
- > Switch down:  
external calibration accessible  
Switch up:  
external calibration blocked
- > Note:  
Do not move Switch 2

### External Calibration in Verified Balances of Accuracy Class 2

- External calibration is blocked when the balance is used in legal metrology
- > External calibration can only be released after removing the verification control seal, in which case the validity of the verification becomes void and the balance must be re-verified
- External calibration can now be performed

### Factory Settings

Calibration/adjustment mode:  
Selection mode (1 9 12)

Calibration/adjustment sequence:  
Adjustment automatically follows calibration in a single operation (1 10 1)

Automatic initiation of calibration/adjustment (isoCAL function):  
isoCAL on (1 15 5)

ISO/GLP printout: off (8 10 1)

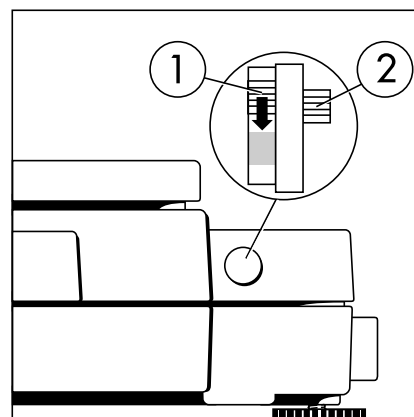







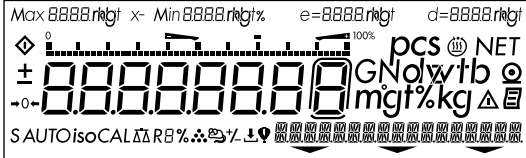
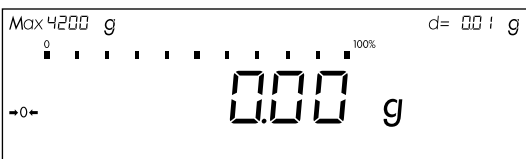

\* including the Signatories of the Agreement on the European Economic Area



## Preparation

Configure Parameters for Calibration and Adjustment

Step	Key (or instruction)	Display/Output
1. Turn on the balance		 
2. Select the Setup menu		
3. Select the Balance Functions menu	MENU soft key 	
4. Set parameters for: <ul style="list-style-type: none"> <li>- Calibration key function : 9</li> <li>- Calibration/adjustment sequence : 10</li> <li>- isoCAL self-calibrating and adjustment function : 15</li> </ul> See the chapter entitled "Setup"		
5. Exit the Setup menu		

## Selecting the Calibration/ Adjustment Parameter





The setting **19 i2** must be selected in the Setup menu.

You can configure the balance so that after selecting a calibration procedure by pressing the **[CAL]** key, you can choose among the following calibration/adjustment modes:

- External calibration/adjustment with the pre-set weight value (**DEF.EXT.ADJ.**)
- External calibration with a user-defined weight value (**USER.EXT.ADJ.**)
- Internal calibration (**INT.ADJUUST**)
- Reproducibility test (**REPROTEST**)

When making your selection, the available modes are displayed in cycles; i.e., after **REPROTEST**, **DEF.EXT.ADJ.** is displayed again

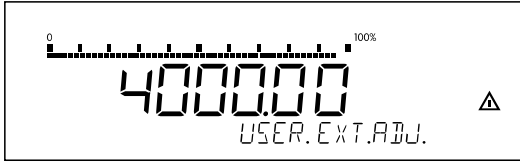
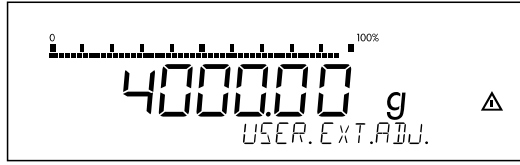
## Configure External Calibration and Automatic Adjustment of the Balance in Selection Mode

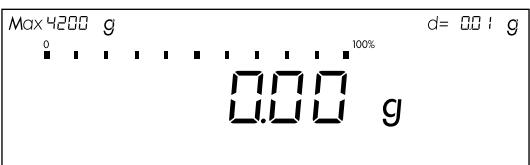
Step	Key (or instruction)	Display/Output
1. Select the calibration function	<b>[CAL]</b>	
2. Select external calibration/ adjustment mode  (for balances of accuracy class <b>II</b> , only "external adjustment" is possible)	Press the <b>SELEC.</b> soft key three times <b>[F]</b>	
3. Confirm external calibration/ adjustment mode	Press the <b>USER.EXT.ADJ.</b> soft key <b>[CAL]</b>	
4. Place the calibration weight on the balance (e.g., 4000.00 g) Minus sign -: Weight too low Plus sign +: Weight too high No plus/minus sign: Weight o.k.	Place weight on balance	
This is displayed after calibration:		
This is displayed after adjustment:		
5. Unload the balance	Remove weight(s)	

## External Calibration/Adjustment\* with a User-Defined Weight

First set either **193** or selection mode (**19 i2**) in the menu.

You can define a weight for calibration/adjustment.





External calibration/adjustment must be performed with weights that are traceable to a national standard and

that have error limits which are at least 1/3 of the required tolerance of the display accuracy.

The balance has a factory-set weight value (see "Specifications").

To reset a user-defined calibration/adjustment weight to the original factory setting, enter the factory-set weight value manually (see "Specifications") or set menu code **19 i** in the Setup menu.

### Define the Calibration Weight

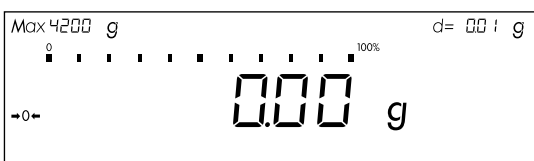
Step	Key (or instruction)	Display/Output
1. Select the Setup menu	<b>SETUP</b>	
2. Access the Input Mode	<b>INPUT</b> soft key <b>F</b>	
3. Select input for calibration weight (currently 3000.00 g)	<b>^</b> <b>^</b> <b>^</b>	
4. Enter calibration weight (e.g., 4000.00 g)	<b>4</b> <b>0</b> <b>0</b> <b>0</b> <b>.</b> <b>0</b> <b>0</b>	
5. Save weight	<b>... WEIGHT</b> soft key <b>F</b>	
6. Exit the Setup menu	<b>SETUP</b>	

\* = for verified balances of accuracy class **II**, only external calibration is possible

## Internal Calibration/Adjustment

The menu code setting **1 9 4** must be selected in the Setup menu.

Inside the balance housing is a built-in, motorized calibration weight.

The internal calibration/adjustment sequence is as follows:

- Select the calibration function:  
Press **CAL**
- > The internal calibration weight is applied automatically
- > The balance is calibrated
- > If the setting for "Calibration automatically followed by adjustment" (**1 10 1**) is selected in the Setup menu, the balance is now automatically adjusted
- > The internal calibration weight is removed

## Calibration and Adjustment Sequence

In the Setup menu, you can configure the balance so that:

- calibration is always followed automatically by adjustment (**CAL. -> AUTO ADJUST. 1 10 1**), or
- you have the choice of ending the sequence or starting adjustment after calibration (**CAL. -> MAN. ADJUST. 1 10 2**).

If no deviation is determined during calibration, or the deviation is within the tolerance limits dictated by the degree of accuracy you require, it is not necessary to adjust the balance.

In this case, you can end the calibration/adjustment sequence after calibration. There are 2 soft keys active at this point:

- **EXT. ADJUST** or **INT. ADJUST** to start adjustment
- **END** to end the sequence

## isoCAL: Automatic Calibration and Adjustment

Either **1 15 3** or **1 15 5** must be selected in the Setup menu.

The "isoCAL" display automatically begins flashing if the ambient temperature has changed in relation to the temperature at the time of the last calibration/adjustment, or after a defined time interval has elapsed. The balance is telling you that it wants to self-calibrate and adjust.

This adjustment prompt is activated when:

- The change in temperature or the elapsed time interval is greater than that shown in the table below
- The balance status does not correspond to Setup configurations
- No number or letter input is active
- The load on the pan has not been changed within the last 2 minutes
- The balance has not been operated within the last 2 minutes
- The weight on the pan must be no more than 2% at the most of the maximum capacity of the balance

When these requirements are met, the following symbols are displayed:

- **⊠** in the measured value line
- **isoCAL** in the symbol display
- **⚠** in the weight unit display

If the balance is not operated and the load is not changed, internal calibration and adjustment starts after 15 seconds have elapsed.

In the Setup menu, you can configure the balance so that after calibration and adjustment

- the application program must be restarted (**ON + RESET APP. 1 15 3**), or
- the application program resumes where it left off (**ISO CAL ON. 1 15 5**)

In the Setup menu, you can also configure the balance so that it displays an adjustment prompt, but does not perform the calibration/functions automatically (**ONLY ADJ. PROMPT. 1 15 2**)

## Deactivating the "isoCAL" Function in Verified Balances:

Automatic calibration is also performed outside of the limited temperature range if you set menu code **1 15 1**, "isoCAL function: off" or code **1 15 2**, "only at adjustment prompt" in the Setup menu.

To generally deactivate automatic calibration in balances with a weighing capacity ≤ 12 kg:

- After the balance has been modified by the Sartorius Service Center
- > Afterwards, the balance can only be used for legal metrology within the temperature range allowed by law

Limited temperature range:

- For balances of accuracy class **I**: +15°C to +25°C (59°F to 77°F)
- For balances of accuracy class **II**: +10°C to +30°C (50°F to 86°F)

Extended temperature range:

- 0°C to +40°C (32°F to 104°F)

Fully automatic adjustment is initiated under the following conditions:

Model	When the temperature changes by	After a time interval of
LP 3200D, LP 1200S	1.5 Kelvin	4 h
LP8200S, LP8200P, LP 620S, LP 620P, LP 6200S, LP 4200S, LP 5200P, LP 220S	2 Kelvin	6 h
LP 2200S, LP 2200P, LP 34000P	4 Kelvin	12 h
LP 820, LP 420, LP 16000S, LP 12000S, LP 12000P, LP 6200, LP 4200, LP 2200, LP 34	4 Kelvin	24 h

These values are also set in the corresponding verified or verifiable balances (LP models with the -OCE designation).

## Determination of the Repeatability (reproTEST)

### Definition

Repeatability (reproducibility) is the ability of the balance to display identical readouts when it is loaded several times with the same weight under constant ambient conditions. The standard deviation for a given number of measurements is used to quantify the repeatability.

### Purpose

The "reproTEST" function automatically calculates the repeatability of results (based on 6 individual measurements). In this way, the balance determines one of the most important quantities in relation to the place of installation. The results are displayed with the balance's accuracy.

### Preparation

- Turn on the balance:  
Press **ON**
- > All display segments light up briefly
- Select reproTEST in the Setup menu: Press **SETUP**
- Select Menu:  
Press **5** (MENU softkey)
- Select either **19 11** (reproTEST) or **19 12** (selection mode):  
See "Configuring the Balance."
- Exit the Setup menu:  
Press **SETUP**

### Check the Reproducibility of the Balance

Step	Key (or instruction)	Display/Output
1. If parameter <b>19 11</b> is set (reproTEST), proceed with step 4.		
2. Access the Selection Mode for calibration/adjustment	<b>CAL</b>	<p>The display shows 'Max 4200 g' at the top left, 'd= 001 g' at the top right, and '0.00 g' in the center. Below the weight, it says 'INT. ADJUST SELEC.' with two arrows pointing to the left and right.</p>
3. Select reproTEST	<b>SELEC.</b> soft key <b>F</b>	<p>The display shows 'Max 4200 g' at the top left, 'd= 001 g' at the top right, and '0.00 g' in the center. Below the weight, it says 'REPROTEST SELEC.' with two arrows pointing to the left and right.</p>
4. Start reproTEST Number of measurements is displayed 6 measurements will now be performed	<b>CAL</b>	<p>The display shows 'Max 4200 g' at the top left, 'd= 001 g' at the top right, and '6' in the center. Below the number, it says 'REPROTEST' with a triangle symbol on the right.</p>
The standard deviation is displayed		<p>The display shows 'Max 4200 g' at the top left, 'd= 001 g' at the top right, and '0.01 g' in the center. Below the weight, it says 'REPROTEST' with a triangle symbol on the right.</p>
5. End reproTEST or restart reproTEST	<b>END</b> soft key <b>F</b> <b>REPROTEST</b> soft key	

## Application Programs

### Using Verified Balances as Legal Measuring Instruments in the EU\*:

All application programs can be selected on balances used as legal measuring instruments. Non-metric values are indicated as follows:

Percent = %

Piece count (counting) = pcs

Computed value = o

## Toggle between Weight Units

### Purpose

With this application program you can switch the display of a weight value back and forth between two weight units by pressing a soft key.

### Available Features

- Toggling the displayed weight
- Setting the display accuracy
- Other features as for the basic weighing function

### Factory Settings

Weight unit 1: Grams/g (1 7 2)

Display accuracy 1 (in the 1st range): All digits (1 8 1)

Weight unit 2: Grams/g (3 1 2)

Display accuracy 2 (in the 2nd range): All digits (3 2 1)

\* including the Signatories of the Agreement on the European Economic Area

\*\* = not applicable in balances verified for use in legal metrology

## Preparation

The following weight units are available in both ranges:

Unit	Conversion factor	Display	Printout
Grams	1.000000000000	g	g
Kilograms	0.001000000000	kg	kg
Carats**	5.000000000000	ct	ct
Pounds**	0.00220462260	lb	lb
Ounces**	0.03527396200	oz	oz
Troy ounces**	0.03215074700	ozt	ozt
Hong Kong taels**	0.02671725000	tl	tlh
Singapore taels**	0.02645544638	tl	tlS
Taiwanese taels**	0.02666666000	tl	tlt
Grains**	15.43235835000	GN	GN
Pennyweights**	0.64301493100	dwt	dwt
Milligrams**	1000.000000000000	mg	mg
Parts per pound**	1.12876677120	o	/lb
Chinese taels**	0.02645547175	tl	tlc
Mommes**	0.266700000000	o	mom
Austrian carats**	5.000000000000	o	K
Tola**	0.08573333810	o	tol
Baht**	0.06578947436	o	bat
Mesghal**	0.217000000000	o	MS

### The following levels of display accuracy are available in both ranges:

- All digits
- Fewer for weight change
- Last digit off (reduced by 1 digit)
- Turn on the balance: Press **ON**
- > All segments of the display light up briefly
- Configure the "Toggle between Weight Units" application in the Setup menu: Press **SETUP**
- Select the configuration mode: Press **5** (MENU soft key)
- Set the parameter 2 1 2: See the chapter entitled "Configuring the Balance"
- Exit the Setup menu: Press **SETUP**

### Setting Weight Unit 1

- Access the Setup menu: select **MENU**
- Set the parameter for weight unit 1 (1 7 2 through 1 7 2 0): See "Configuring the Balance"
- Set display accuracy 1 (1 8 1 through 1 8 5): See "Configuring the Balance"

### Setting Weight Unit 2

- Access Setup: select **MENU**
- Set the parameter for weight unit 2 (3 1 2 through 3 1 2 0): See "Configuring the Balance"
- Set display accuracy 2 (3 2 1 through 3 2 5): See "Configuring the Balance"
- Exit the Setup menu: Press **SETUP**

## Additional Functions

In addition to the functions for:

- alphanumeric input,
- taring  
(not during alphanumeric input),
- printing,

you can also access the following functions from this application:

- calibration  
(not during alphanumeric input),
- setup,
- turning off the balance.

### Calibration/Adjustment

- Press **CAL**
- > See "Calibration/Adjustment" for further instructions

### Setup (setting parameters)

- Press **SETUP**
- > See "Configuring the Balance" for further instructions

### Turning Off the Balance

- Press **POWER**
- > The balance shuts off
- > The display goes blank

## Practical Example

Toggle the Display From Grams [g] (1st Unit) to Troy Ounces [ozt] (2nd Unit)

Step	Key (or instruction)	Display/Output
(R1: weight unit 1)		
1. Toggle to Troy ounces [ozt] (R2: weight unit 2)	OZT soft key <b>F</b>	
2. Toggle to grams [g]	G soft key <b>F</b>	



## Counting

### Purpose

With the Counting program you can determine the number of parts that each have approximately equal weight.

### Available Features

- Reference sample quantity "nRef" loaded from long-term memory when you turn on the balance
- Optional balance configuration in the Setup menu for automatically initializing this application and loading the most recent reference sample quantity "nRef" and average piece weight "wRef" when you turn on the balance (automatic initialization; menu code  $\text{3 } \text{I} \text{2 } \text{I}$ )
- Minimum load checked when the balance is initialized (factory setting: 10 display increments; can only be changed by the Sartorius FastFactory)
- Reference sample quantity "nRef" entered using the keys
- Average piece weight "wRef" entered using the keys
- Storage parameter (level of accuracy with which the average piece weight "wRef" is stored) for piece count calculation can be configured
- Optional configuration for having the piece count and average piece weight output automatically via the data interface port after initialization or reference sample updating while running the Counting program (print application parameters)
- Long-term storage of the last reference sample quantity "nRef" entered
- Long-term storage of the last average piece weight "wRef" entered with the corresponding reference sample quantity "nRef," by configuring automatic initialization
- Toggling between two weight units by pressing  $\text{I} \text{5}$
- Counting program initialized again after using the balance for weighing (after initialization)

### Factory Settings

Auto-start application (automatic initialization with reference sample quantity and average piece weight loaded from long-term memory): off ( $\text{3 } \text{I} \text{2}$ )

Counting/percent parameter (accuracy when storing average piece weights): display accuracy ( $\text{3 } \text{5 } \text{2}$ )

Printout application parameters (automatic output of application parameters): off ( $\text{7 } \text{I } \text{I}$ )

## Preparation

To calculate a piece count, the average weight of one piece must be known. This average piece weight can be entered into the Counting program in one of three ways:

- The last reference sample quantity entered is loaded and displayed when you turn on the balance. Place the same number of parts on the balance and initialize the counting program;
- With automatic initialization switched on, the balance goes into the "counting" mode when you turn it on and loads the last average piece weight and corresponding reference sample quantity that were entered or calculated;
- Enter the average piece weight using the numeric keys and store it.

## Reference Sample Updating

When the **UPDRT** soft key is displayed during counting, this means you can have the average piece weight updated (while the piece count is displayed in the measured value line).

The **UPDRT** soft key is displayed when:

- the balance has reached stability
- the current piece count is less than double the original piece count
- the current piece count is less than 100
- the internally calculated piece count (e.g., 17.24 pcs) differs from the nearest whole number (here: 17 pcs) by less than 0.3

Reference sample updating can be repeated several times with an approximately doubled piece count.

- To perform reference sample updating: Press **[F]** (**UPDRT** soft key)
- Turn on the balance: Press **[I/O]**
- > All display segments light up briefly
- Select the Counting program in the Setup menu: Press **[SETUP]**
- Select menu: Press the **MENU** soft key (**[5]**)
- Set parameter **2 1 4**: See "Configuring the Balance"
- Exit the Setup menu: Press **[SETUP]**

## Setting Parameters for the Counting Application

- Access the Setup menu: Select **MENU**
- Set parameters for:
  - Storage accuracy: **3 5 COUNT/PCT.PARAM.**
  - Automatic initialization: **3 10 AUTO-START APP.**
  - Automatic output of parameters to interface port: **7 1 PRINT APP.PARAM.**See "Configuring the Balance"
- Exit the Setup menu: Press **[SETUP]**

## Additional Functions

In addition to the functions for:

- alphanumeric input,
- taring (not during alphanumeric input),
- printing,

you can also access the following functions from this application:

- calibration (not during alphanumeric input),
- setup,
- turning off the balance.

## Calibration/Adjustment

- Press **[CAL]**
- > See "Calibration/Adjustment" for further instructions

## Setup (setting parameters)







- Press **[SETUP]**
- > See "Configuring the Balance" for further instructions

## Turning Off the Balance

- Press **[I/O]**
- > The balance shuts off
- > The display goes blank

## Practical Example

Counting with: Preset Reference Sample Quantity Weighed In  
 (Parameter settings: Counting program: 2 14; Print all parameters: 7 12)

Step	Key (or instruction)	Display/Output
1. Select the counting application in the Setup menu	see "Preparation"	
2. Prepare a container for the parts	Place the empty container on the balance	
3. Tare the balance	TARE	
4. Place reference sample quantity on the balance (example: 10 pcs, each weighing 2.148 g)	Place the displayed number of parts in the container	
5. Initialize the balance (the number of digits following the decimal point depends on the balance model)	START soft key [F]	
6. If necessary, increase number of parts and update the reference sample (here: 7 more pieces)	Place parts in container UP PART soft key [F]	
7. Weigh uncounted parts	Place parts to be counted in container	
8. If desired, print total piece count (here: 153 pcs)	Print	<pre>nRef      10 pcs wRef      2.14800 g Qnt      + 153 pcs</pre>

## Weighing in Percent %



### Purpose

This application program allows you to obtain weight readouts in percent which are in proportion to a reference weight.

### Available Features

- Reference percentage “pRef” loaded from long-term memory when you turn on the balance
- Optional balance configuration in the Setup menu for automatically initializing this application and loading the most recent reference percentage “pRef” entered with reference weight “w100%” when you turn on the balance
- Minimum load checked when the balance is initialized (factory setting: 10 display increments; can only be changed by the Sartorius FastFactory)
- Reference percentage “nRef” entered using the numeric keys
- Reference weight “Wxx%” entered using the numeric keys
- Storage parameter (rounding-off factor) for storing the reference weight “W100%” to calculate the percentage can be configured
- Configuration of decimal places displayed with a percentage
- Optional configuration for having the reference weight “Wxx%” and reference percentage automatically output via the data interface port after initialization of the weighing-in-percent program (print application parameters)
- Long-term storage of the last reference percentage “pRef” entered
- Long-term storage of the last reference weight “W100%” entered, by configuring automatic initialization (auto-start)
- Toggle between two weight units by pressing 

### Factory Settings

Auto-start application (automatic initialization with reference percentage and reference weight loaded from long-term memory): off (   2 )

Counting/percent parameter (accuracy when storing reference weights): display accuracy (  5 2 )

Number of decimal places displayed in “weighing in percent” mode: 2 decimal places (  5 3 )

Printout application parameters (automatic output of application parameters): off (  1 1 )

## Preparation

To calculate a value in percent, the reference percentage must be known. This value can be entered into the weighing-in-percent program in one of three ways:

- The last reference percentage entered is loaded and displayed when you turn on the balance. Place the corresponding weight on the balance and initialize the weighing-in-percent program;
- With automatic initialization switched on, the balance goes into the "weighing in percent" mode when you turn it on and loads the last reference percentage entered as well as the corresponding reference weight;
- Enter the reference weight using the numeric keys and store it ( $\text{W } 100\%$  soft key).

- Turn on the balance:  
Press  $\text{I/O}$
- > All display segments light up briefly
- Select the Weighing-in-Percent application in the Setup menu:  
Press  $\text{SETUP}$
- Select menu:  
Press the  $\text{MENU}$  soft key ( $\text{G}$ )
- Set parameter  $2 \ 1 \ 5$ :  
See "Configuring the Balance"
- Exit the Setup menu:  
Press  $\text{SETUP}$

## Setting Parameters for the Weighing-in-Percent Application

- Access the Setup menu:  
Select  $\text{MENU}$
- Set parameters for:
  - Storage accuracy:  
 $3 \ 5 \ \text{COUNT/PCT. PARAM.}$
  - Decimal places displayed:  
 $3 \ 6 \ \text{DECIMALS F. CALC.}$
  - Automatic initialization:  
 $3 \ 10 \ \text{AUTO-START APP.}$
  - Automatic output of parameters to interface port:  
 $7 \ 1 \ \text{PRINT APP. PARAM.}$
- See "Configuring the Balance"
- Exit the Setup menu:  
Press  $\text{SETUP}$

## Additional Functions

In addition to functions for:

- alphanumeric input,
- taring (not during alphanumeric input),
- printing,

you can also access the following functions from this application:

- calibration (not during alphanumeric input),
- setup,
- turning off the balance.

## Calibration/Adjustment

- Press  $\text{CAL}$
- > See "Calibration/Adjustment" for further instructions

## Setup (setting parameters)





- Press  $\text{SETUP}$
- > See "Configuring the Balance" for further instructions

## Turning Off the Balance

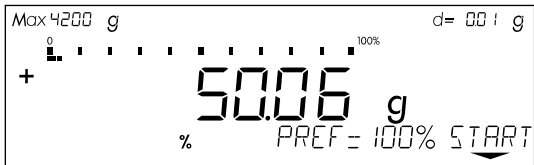

- Press  $\text{I/O}$
- > The balance shuts off
- > The display goes blank

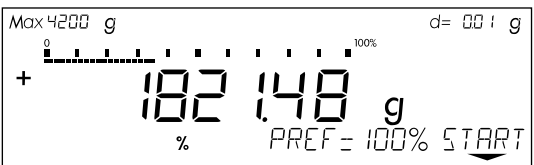
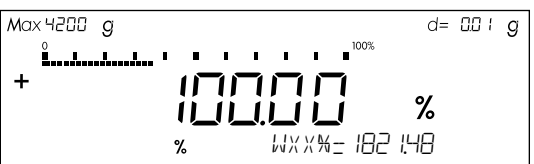
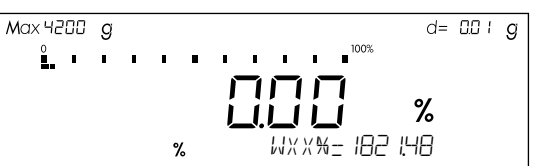
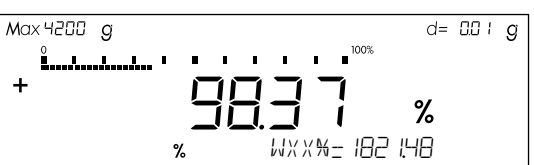
## Practical Examples

### Example P1: Weighing in Percent with Reference Weight Taken from Weight on Balance

Step	Key (or instruction)	Display/Output									
1. Select the weighing-in-percent application in the Setup menu	see "Preparation"										
2. Prepare a container for the parts on the balance	Place the empty container on the balance										
3. Tare the balance	<b>TARE</b>										
4. Place the reference weight on the balance (here: 1821.48 g = 100%)	Place weight equal to reference weight in the container										
5. Initialize the balance	<b>START</b> soft key <b>F</b>										
6. Unload the balance	Remove reference weight from the container										
7. Determine the percentage of an unknown weight	Place sample to be measured in the container										
8. If desired, print percentage (here: 98.37%)		<table border="1" data-bbox="874 1686 1264 1792"> <tr> <td>pRef</td> <td>100</td> <td>%</td> </tr> <tr> <td>Wxx%</td> <td>1821.48</td> <td>g</td> </tr> <tr> <td>Prc</td> <td>+ 98.37</td> <td>%</td> </tr> </table>	pRef	100	%	Wxx%	1821.48	g	Prc	+ 98.37	%
pRef	100	%									
Wxx%	1821.48	g									
Prc	+ 98.37	%									

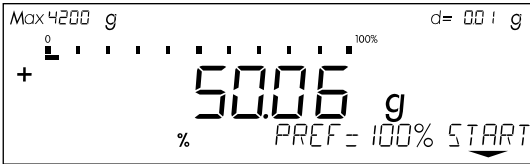
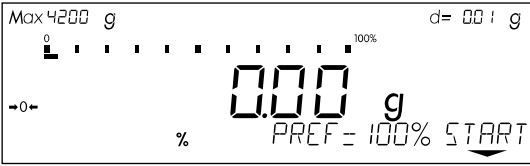
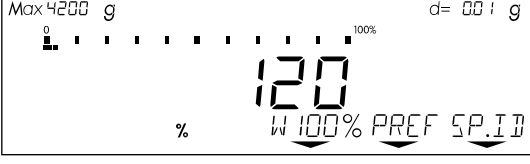
## Example P2: Weighing in Percent with Reference Weight Entered Using the Numeric Keys

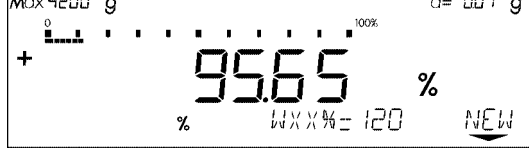

Step	Key (or instruction)	Display/Output
1. Select the weighing-in-percent application in the Setup menu	see "Preparation"	
2. Prepare a container for the parts on the balance	Place the empty container on the balance	
3. Tare the balance	<b>TARE</b>	
4. Enter the reference weight using the numeric keys (here: 120 g)	<b>1</b> <b>2</b> <b>0</b>	
5. Store the reference weight	<i>W 100%</i> soft key <b>CAL</b>	
6. Determine the percentage of an unknown weight	Place sample to be measured in the container (in this case: 114.78 g)	

## Net-Total Formulation

### Purpose

With this application program you can weigh in different components up to a defined total. You can also print out the total weight and the individual weights of the components.



### Available Features

- Taring
- Weighing different components (maximum: 99 components) from "0" to a defined total component weight
- Storing component weights ("Store xx comp."), with
  - display zeroed after value stored, and
  - automatic printout (print application parameters); either
    - of the last component weight (net value) or
    - of the total weight (tare value)
- Display of the transaction counter "XXth" (referring in each case to the next component) in the soft key label display
- Clearing of the component memory when the weighing series is canceled  and printout of the total weight if you have configured the balance for GLP-compliant printouts; otherwise, printout of the net value 
- Toggling between component weight and total weight by pressing .
- ISO/GLP-compliant printout of the total of the individual component weights (**T o t . c p**)

### Factory Settings

Automatic printout when component value stored: print net total (7 3 !)

### Preparation

- Turn on the balance
- > All display segments light up briefly
- Select the Net Total application in the Setup menu: Press 
- Select menu: Press the *MENU* soft key ()
- Set parameter 2 1 5: See "Configuring the Balance"
- Exit the Setup menu: Press 

### Setting Parameters for the Net-Total Application

- Access the Setup menu: Select *MENU*
- Set the parameter for automatic printout when component stored  
7 3 *PRINT NET TOTAL*  
See "Configuring the Balance"
- Exit the Setup menu: Press 

### Additional Functions

In addition to functions for:

- alphanumeric input,
- taring (not during alphanumeric input),
- printing,

you can also access the following functions from this application:

- calibration (not during alphanumeric input),
- setup,
- turning off the balance.

### Calibration/Adjustment

- Press 
- > See "Calibration/Adjustment" for further instructions

### Setup (setting parameters)

- Press 
- > See "Configuring the Balance" for further instructions

### Turning Off the Balance







- Press 
- > The balance shuts off
- > The display goes blank



## Practical Example

Weighing in Several Components

(Parameter settings: Net-total application program 2 1 5; print all parameters 7 1 2)

Step	Key (or instruction)	Display/Output
1. Select the net-total application in the Setup menu	see "Preparation"	
2. Prepare a container for the components	Place the empty container on the balance	
3. Tare the balance	<b>TARE</b>	
4. Add first component	Place the first component in the container	
5. Store component value	1.COMP soft key <b>F</b>	<div style="border: 1px solid black; padding: 2px; display: inline-block;">Comp1 + 952.48 g</div> 
6. Add next component	Place next component in the container	
7. Store component value	2.COMP soft key <b>F</b>	<div style="border: 1px solid black; padding: 2px; display: inline-block;">Comp1 + 952.48 g Comp2 + 2837.12 g</div>
8. If desired, add further components	Repeat steps 6 and 7 as needed	
9. Display total weight	<b>S</b>	

## Animal Weighing

### Purpose

Use this program to determine the weights of unstable samples (e.g., live animals) or to determine weights under unstable ambient conditions. In this program, the balance calculates the weight as the average of a defined number of individual weighing operations. These weighing operations are also known as "subweighing operations."

### Available Features

- Animal weighing started manually or automatically
- Optional balance configuration in the Setup menu for automatically initializing this application when you turn on the balance
- Minimum load threshold for starting animal weighing:
  - 100 display increments for automatic start
  - 50 display increments for manual start
- Start range: Automatic start of animal weighing operation when three successive subweights lie within a user-defined tolerance range (calm = 2%, normal = 5%, active = 10%)
- Number of weighing operations for calculation of an average *MDEF* can be set before the beginning of each animal weighing operation
- Arithmetic average displayed as a result in the pre-set weight unit (identified by the  $\Delta$  symbol)
- Optional multiplication of the arithmetic average by a user-defined factor *MUL*. A circle "o" is displayed as weight unit and *MUL = XXXX* is shown in the text line
- Toggling between weighed and calculated results by pressing 
- Automatic output via the interface port:
  - Number of weighing operations **mDef**
  - Multiplication factor **MuL**
- Automatic output of results via the interface port:
  - Weighing result **x-Net**
  - Calculated result **x-Res**
- Stop limit: Unload threshold (50 display increments)
- Return to weighing mode by unloading the balance; i.e., when the load is below the stop threshold

### Factory Settings

Auto-start application (automatic initialization with automatic start of animal weighing): off (3 10 2)

Animal activity (3 subweights lie within a preset range; i.e., animal is calm, normal or active): normal (3 7 2)

Start animal weighing: automatic (3 8 2)

Automatic printout of number of weighing operations used in averaging and of the calculation factors: off (7 1 1)

Print animal weights (automatic printout of weighed or calculated result):

On: animal wt. (3 9 2)

## Preparation

- Turn on the balance:  
Press **[I/O]**
- > All display segments light up briefly
- Select the animal weighing application in the Setup menu:  
Press **[SETUP]**
- Select menu:  
Press the *MENU* soft key (**[5]**)
- Set parameter **2 1 7**:  
See "Configuring the Balance"
- Exit the Setup menu:  
Press **[SETUP]**

## Setting Parameters for the Animal Weighing Application

- Access the Setup menu:  
Select *MENU*
- Set parameters for:
  - Start range:  
**3 7 ANIMAL ACTIVITY**
  - Start animal weighing  
**3 8 START ANIMAL WSH.**
  - Printout of results and calculated results:  
**3 9 PRINT ANIMAL WTS.**
  - Automatic output to interface port:  
**7 1 PRINT APP. PARAM.**
- See "Configuring the Balance"
- Exit the Setup menu:  
Press **[SETUP]**

## Additional Functions

In addition to functions for:

- alphanumeric input (not when automatic start is configured or after animal weighing has been started),
- taring (not during alphanumeric input),
- printing,

you can also access the following functions from this application:

- calibration (not during alphanumeric input or after animal weighing has been started),
- setup (not after animal weighing has been started),
- turning off the balance.

## Calibration/Adjustment

- Press **[CAL]**
- > See "Calibration/Adjustment" for further instructions

## Setup (setting parameters)

- Press **[SETUP]**
- > See "Configuring the Balance" for further instructions

## Turning Off the Balance







- Press **[I/O]**
- > The balance shuts off
- > The display goes blank

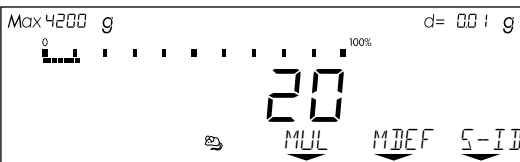

## Practical Example

See next page

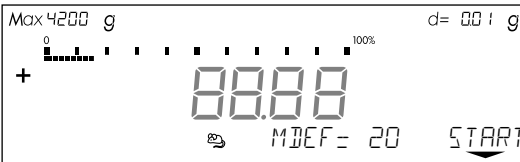
## Practical Example

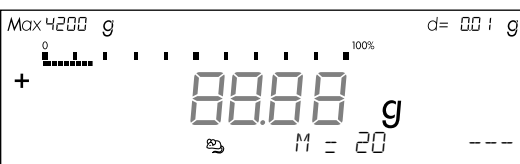
Determining Animal Weight with Automatic Start of 20 Subweighing Operations for Averaging;  
Automatic Printout of the Number of Subweighing Operations and of the Animal Weight

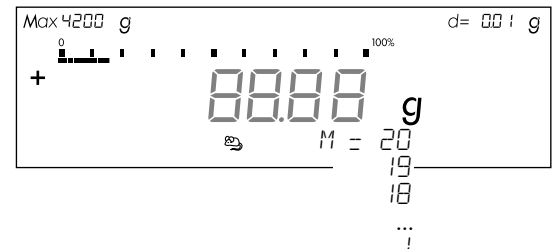
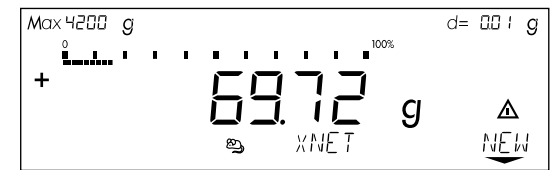
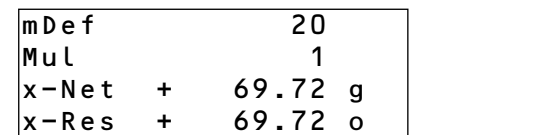
Step	Key (or instruction)	Display/Output
1. Select the animal weighing application in the Setup menu	see "Preparation"	
2. Set the following animal weighing parameters in the Setup menu: – Animal activity: Active – Start animal weighing: Automatic – Printout: On: anim.wt.*fact. – Print: All parameters	Setting 3 7 3 in Setup menu Setting 3 8 2 in Setup menu Setting 3 9 3 in Setup menu Setting 7 1 2 in Setup menu	
3. Prepare a container (cage)	Place empty cage on the balance	 The display shows a maximum weight of 4200 g and a current weight of 432.06 g. A small bar graph is visible on the left. The unit is g. The display also shows 'MDEF = 10' and 'START'.
4. Tare the balance	TARE	 The display shows a maximum weight of 4200 g and a current weight of 0.00 g. The unit is g. The display also shows 'MDEF = 10' and 'START'.
5. Enter number of subweighing operations for averaging	2 0	 The display shows a maximum weight of 4200 g and a current value of 20. The unit is g. The display also shows 'MDEF = 20' and 'START'.
6. Save number	MDEF soft key 	 The display shows a maximum weight of 4200 g and a current weight of 0.00 g. The unit is g. The display also shows 'MDEF = 20' and 'START'.
7. Weigh the first animal	Place 1st animal in cage	weight value fluctuates due to animal activity  The display shows a maximum weight of 4200 g and a current weight of 0.00 g. The unit is g. The display also shows 'MDEF = 20' and 'START'.
8. Start automatic animal weighing	START soft key 	 The display shows a maximum weight of 4200 g and a current weight of 0.00 g. The unit is g. The display also shows 'M = 20' and '---'.

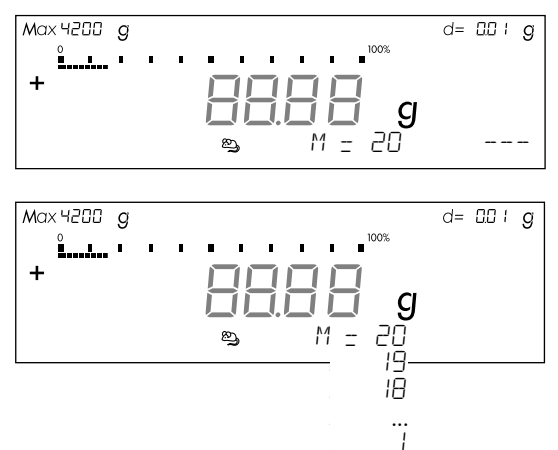
Step	Key (or instruction)	Display/Output
The balance delays starting the subweighing operation until three successive subweights lie within the range defined for an "active" animal	When this criterion is met, the subweighing series begins	
After 20 subweighing operations (mdef: no. of subweighs) Mul: Calculation factor XNET arithm. average, net value)		
8. Unload the balance	Remove animal from cage	
9. If desired, weigh next animal	Place animal in cage	
Next weighing series begins automatically		

## Over/Under Checkweighing +/-

### Purpose

This program is used to check whether a sample corresponds to a pre-set target value or is within a specific tolerance range. In addition to the display in the measured value line, the results are shown on the bar graph and can also be routed through the interface port via control lines for further electronic processing.

### Available Features

- Lower tolerance limit (minimum), target value and upper limit (maximum) stored in long-term memory
- Optional balance configuration in the Setup menu for automatically initializing this application and loading the values stored in long term memory for the target value and the upper and lower tolerance limits when you turn on the balance
- Enter target value and limits by placing a load on the balance or using the numeric keys
- Control in entering target and tolerance values, so that the upper limit  $\geq$  the target  $\geq$  the lower limit  $\geq$  1 display increment
- Accuracy of a weight readout or keyboard input as target/tolerance value stored corresponds to the display accuracy
- Optional balance configuration in the Setup menu for automatic output to the interface port (print application parameters) of target value and tolerance limits when initialization is completed
- Control range for the balance's data output port lines is 30% to 170% of the target value
- Control range can be set anywhere from 10% to infinity. Control lines set when stability is reached within the control range; deleted only when you exit this application
- Optional configuration in the Setup menu for activation of control lines independent of weight value (weight within control range, stability reached)

- Toggling the display between weight readout and control (checkweighing) display by pressing **[F]**. If the weight value exceeds tolerances, the measured value line shows the weight while the control display shows "LL" for "too low" or "HH" for "too high."
- Toggle the text line display between weight value and control display, nominal value "SETP" and tolerance values "MIN" and "MAX" by pressing the **[S]** key.
- Weight displayed on bar graph in relation to upper and lower limits and target value.
- Optional automatic printout of weight when it is within the control range at stability (AUTO PRINT +/-).  
After an automatic printout, the balance is blocked. Before you can generate the next printout, you must unblock the balance by unloading it (weight must be under 30% of the target) or by placing a load on the balance (bringing the weight up to at least 170% of the target).
- Press **[CF]** to delete the initialization parameters and end the over/under checkweighing program

### Factory Settings

Auto-start application (automatic initialization with target value and tolerance limits loaded from long-term memory): off (3 0 2)

Automatic output of target value and tolerance limits via the interface port (print application parameters): off (7 1 !)

Auto print +/- (automatic printout of a weight when it is within the control range at stability): off (4 2 2)

Control lines +/- on (activating data output port lines): Within control range (4 3 !)

## Preparation

The checkweighing program requires a target value for comparison to the current value. This target has a tolerance range, which is defined by absolute weight values: upper and lower limits. These limits can be entered either by storing weights on the balance or via key input.

There are four control lines, called data output port lines, which are activated as follows: (see also the diagram at the right):

- lighter
- equal
- heavier
- set

The control range spans 30% to 170% of the target value. You can configure this parameter in the Setup menu (4 3 +/- CTRL PORTS ON) to select whether the control lines are:

- always on
- activated within the control range
- activated at stability
- activated at stability within the control range

This makes it possible, for example, to connect a simple indicator for the weighing results (e.g., three different colors, one each for the weighing results: too light, O.K., too heavy).

## Response of Control Lines During Checkweighing

Configurations:

- always on
- activated at stability

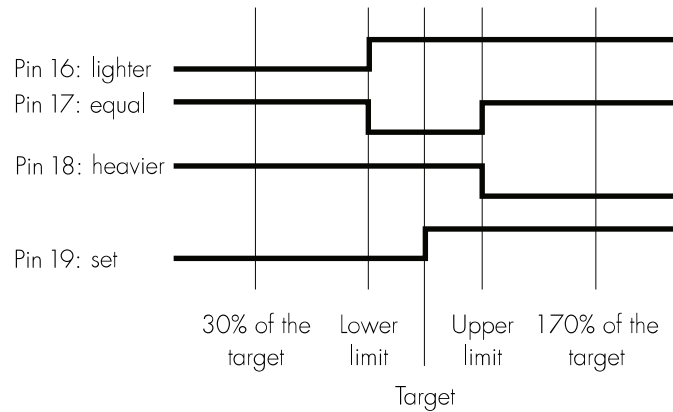

Configurations:

- activated within control range
- activated at stability within control range

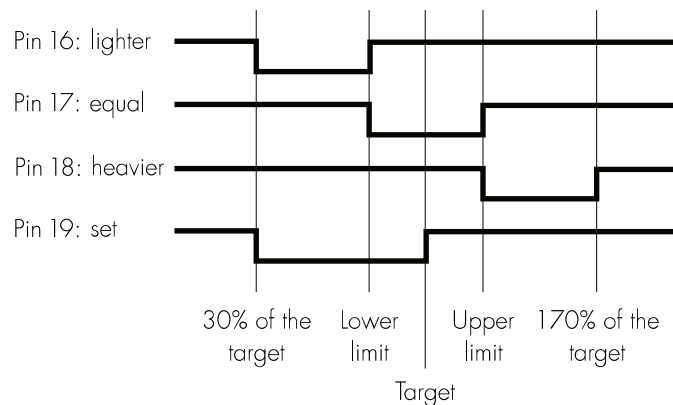

## Output port specifications

When not in use, the voltage level is high:  $>2.4\text{ V}/+2\text{ mA}$

When in active use, the voltage level is low:  $<0.4\text{ V}/-2\text{ mA}$ .

⚠ The output ports are not protected against short circuits!

- Turn on the balance:  
Press **⏻**
- > All display segments light up briefly
- Select the over/under checkweighing application in the Setup menu: Press **SETUP**
- Select menu:  
Press the **MENU** soft key (**☰**)
- Set parameter **2 1B**:  
See "Configuring the Balance"
- Exit the Setup menu:  
Press **SETUP**

#### Setting Parameters for the Over/Under Checkweighing Application

- Access the Setup menu:  
Select **MENU**
- Set parameters for:
  - Automatic initialization when balance switched on:  
**3 1B AUTO-START APP.**
  - Automatic printout when weight value is within limits and balance at stability:  
**4 2 AUTO PRINT +/-**
  - Control lines on:  
**4 3 +/- CTRL PORTS ON**  
  
Automatic output of initialization values to interface port:  
**7 1 PRINT APP. PARAM.**
  - Signal direction for data output port lines:  
**8 8 1 INPUT** or  
**8 8 2 OUTPUT**
- See "Configuring the Balance"
- Exit the Setup menu:  
Press **SETUP**

#### Additional Functions

In addition to functions for:

- alphanumeric input (not during initialization),
- taring (not during alphanumeric input),
- printing,

you can also access the following functions from this application:

- calibration (not during alphanumeric input or during initialization),
- setup (not during initialization),
- turning off the balance.

#### Calibration/Adjustment

- Press **CAL**
- > See "Calibration/Adjustment" for further instructions

#### Setup (setting parameters)

- Press **SETUP**
- > See "Configuring the Balance" for further instructions





#### Turning Off the Balance

- Press **⏻**
- > The balance shuts off
- > The display goes blank

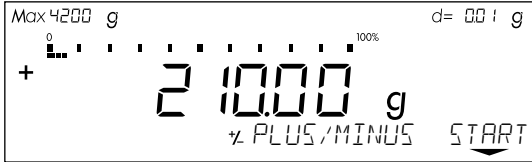
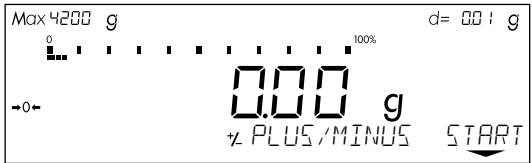

## Practical Example

Checkweighing samples of 170 g, with an allowable tolerance of  $-5$  g and  $+10$  g.  
Printout of upper and lower tolerance limits. Weighed values printed out automatically when stability is reached and weight is within the control range.

Step	Key (or instruction)	Display/Output
1. Select the checkweighing application in Setup	see "Preparation"	
2. Set the following checkweighing parameters in the Setup menu: – Auto print +/-: On: values in tol. – Print app. param.: All parameters	See "Configuring the Balance"	
3. Prepare a container for the sample	Place empty container on the balance	
4. Tare the balance	<b>TARE</b>	
5. Enter initialization values	<b>START</b> soft key <b>F</b>	
6. Store target value (here: 170 g)	Place ideal sample in container	
7. Store target value and unload balance	<b>SETP</b> soft key <b>F</b> Remove ideal sample from balance	
8. Enter value for lower limit (170 g – 5 g)	<b>1</b> <b>6</b> <b>5</b>	

9. Store lower limit value

MIN soft key



10. Enter value for upper limit  
(170 g + 10 g)

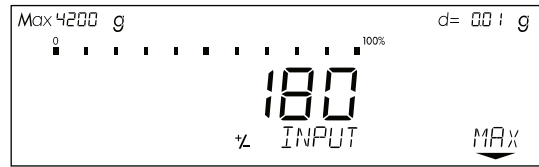

11. Store upper limit value

MAX soft key

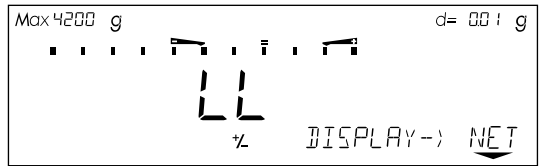

Setp	+	170.00 g
Min	+	165.00 g
Max	+	180.00 g

12. Weigh sample  
(in this case 169.48 g)

Place sample in container

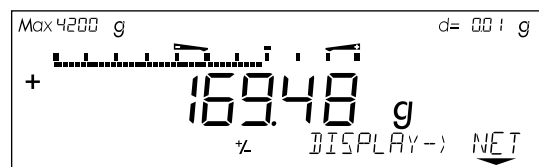

N	+	169.48 g
---	---	----------

If the weight had been too low, the display would have shown the following:

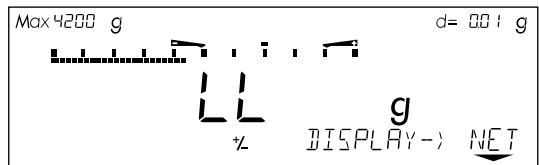

13. In this case, switch to net value display (in this case: 163.28 g)

NET soft key

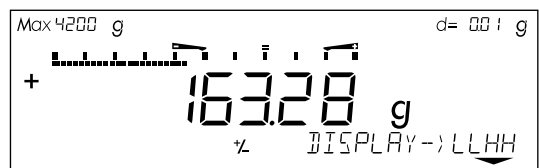

14. Weigh next sample (if any)

Place sample in container

## Recalculation

### Purpose

With this application program you can compensate for over-poured components in formulation.

If a component is over-poured when weighing in the individual formulation components, the mixture already poured cannot be used in its current composition. To avoid having to discard the materials weighed, you can adjust the proportions of the formulation to compensate for the over-pour.

When you use this application, the recalculation procedure is mainly performed by the balance.

### Available Features





- Individual components (up to 99) weighed in with a readout showing from "0" to the desired component weight
- Transaction counter shows the next component expected
- Weighed components are stored, followed by automatic printout and taring
- Additive weighing of components with printout
- Toggle the display between component weight and total formulation weight (additive mode) after first component is stored
- Stored component weight displayed as true net weight for 2 seconds
- Enter a divisor before or during component weighing. For example, if the formulation has a total weight of 100 g, enter the divisor 10 to weigh in a total formulation of 1,000 g.
- If a component is over-poured, you can use the recalculation function to change the amount of this component indicated in the formulation by using plus or minus keys or numeric input. A factor is then calculated by which all components amounts are then adjusted.
- Recalculation factor displayed in the text line, with a warning symbol if the factor is not equal to 1.
- All components displayed with number and the amount (by weight) to be added in follow-on filling. Components displayed in sequence by the balance.
- Display of actual net weight during follow-on filling
- After the amounts of the components already weighed have been corrected, weighing continues according to the adjusted formulation amount. The readout is recalculated (updated) according to the divisor.
- You can repeat the over-pour correction procedure as often as necessary, in case other components are over-poured.
- After follow-on (corrective) filling, the total amount differs from that given for the formulation, but the proportion of components in relation to each other is the same.
- You can have the weight printed after each measurement
- Choose whether the current component weight or the tare value is printed after each measurement
- Individual component weights are printed as "Compxx."
- Press **[CF]** to exit the application program. The component memory is cleared and the sum of components printed as "S-Comp."

## Factory Settings

Print application parameters  
(automatic output of application  
parameters): off (7 1 1)

Line format: for other apps/GLP  
(7 2 2)

## Preparation

- Turn on the balance: Press 
- > All display segments light up
- Select the Recalculation application in the Setup menu: Press 
- Select menu:  
Press the menu soft key ()
- Set parameter 2 1 9:  
see "Configuring the Scale"
- Exit the Setup menu: Press 

## Setting Parameters for the Recalculation Application

- Access the Setup menu:  
Select *MENU*
- Set parameters for:
  - Automatic printout:  
7 1 *PRINT APP. PARA.*
  - Line format:  
7 2 *LINE FORMAT*  
see "Configuring the Balance"
- Exit the Setup menu: Press 

## Additional Functions

In addition to the functions for:

- alphanumeric input,
- taring (not during alphanumeric input), and
- printing,

you can also access the following  
functions from this application:

- calibration  
(not during alphanumeric input)
- setup
- turning off the balance.

## Calibration/Adjustment

- Press 
- > See "Calibration/Adjustment"  
for further instructions

## Setup (setting parameters)



- Press 
- > See "Configuring the Balance"  
for further instructions

## Turning Off the Balance

- Press 
- > The balance shuts off
- > The display goes blank

## Practical Example

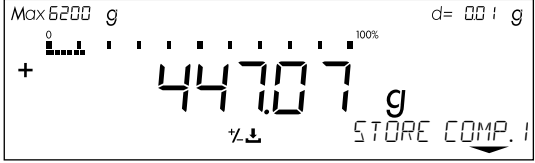
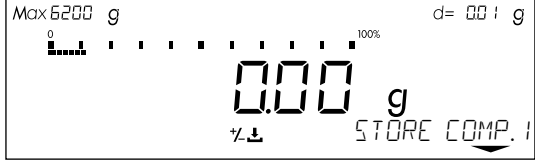
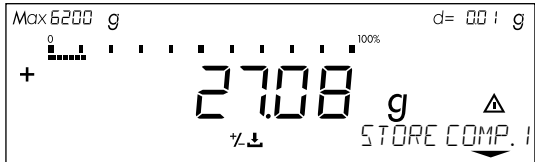
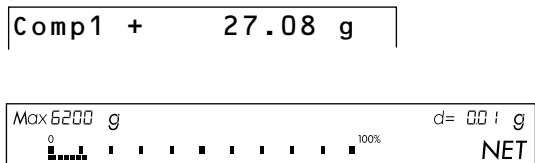
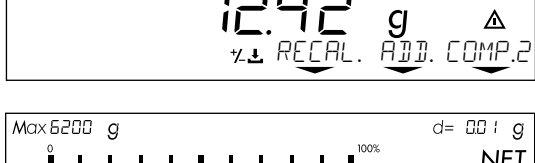
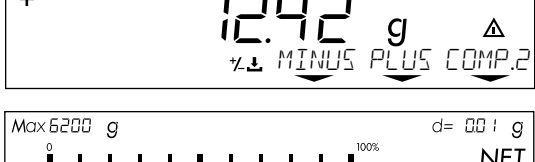
When weighing in formulation components, the second component is over-poured.  
 (Parameter settings: Recalculation application: 2 1 9; Print all parameters: 7 1 2)

Step	Key (or instruction)	Display/Output
1. Select the recalculation application in the Setup menu	see "Preparation"	
2. Place container for filling components on the balance	Place empty container on the balance	
3. Tare	<b>TARE</b>	
4. Add the first component	Weigh the first component into the container	 <b>Comp1 + 27.08 g</b>
5. Store component	Press the <i>COMP. 1</i> soft key ( <b>F</b> )	
6. Add the second component	Weigh the second component into the container	
7. Start recalculation, because 12.42 g were poured rather than 12.30 g	<i>RECAL</i> soft key ( <b>CAL</b> )	
8. Either press the minus key to correct the value...	<i>MINUS</i> soft key repeatedly	

... or enter the desired value

1 2 . 3 0

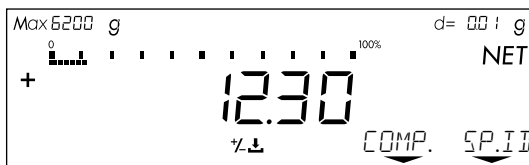

9. Confirm the new value

COMP.2 soft key (F) or COMP. soft key (S)

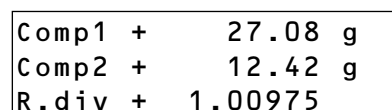

The true net value is displayed for 2 seconds

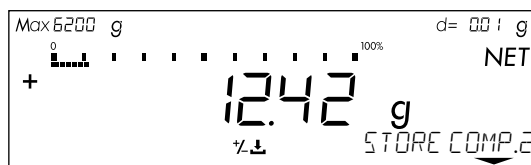

Follow-on filling amount for first component is displayed

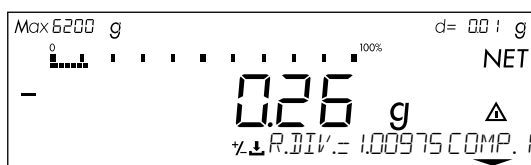

10. Follow-on filling of 1st component Weigh the first component up to 0

and store

COMP. 1 soft key (F)

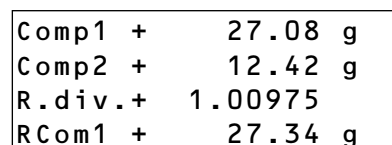

The true net value is displayed for 2 seconds



11. Weigh in further components, if called for in the formulation

Repeat steps 4 and 5 as needed

12. Toggle to the additive mode, if required

ADD. soft key (S)

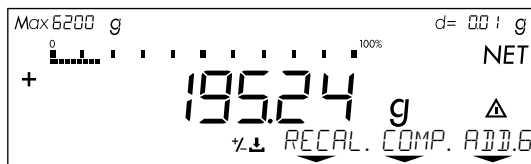

13. Add further components, as required ... (here, e.g., up to the total weight of the formulation: 1,000 g)

Add components to container

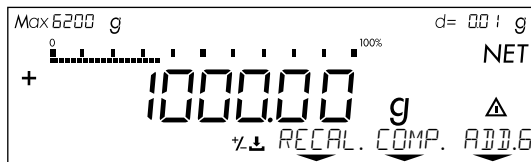

14. ... and store  
(here, e.g., the 6th component)

ADD soft key (F)

Comp1 +	27.08 g
Comp2 +	12.42 g
R.div.+	1.00975
RCom1 +	27.34 g
Comp3 +	18.39 g
Comp4 +	31.49 g
Comp5 +	107.50 g
Comp6 +	812.61 g

The true net value (of the 6th component) is displayed for 2 seconds

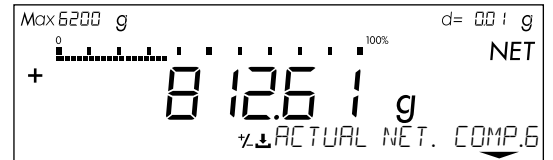

Then the total weight is displayed

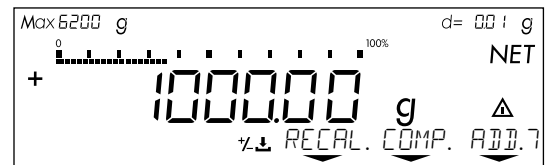

15. End the weighing procedure  
Total weight is printed

CF

Comp1 +	27.08 g
Comp2 +	12.42 g
R.div.+	1.00975
RCom1 +	27.34 g
Comp3 +	18.39 g
Comp4 +	31.49 g
Comp5 +	107.50 g
Comp6 +	812.61 g
Tot. cp+	1009.75 g

Total weight is displayed  
Component memory is cleared

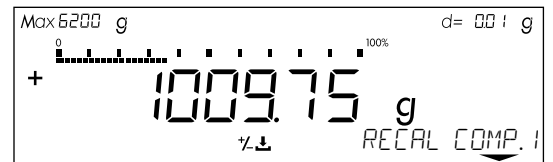

## Data Output Functions

There are 3 options for data output:

- Output to the display/control unit
- Output to a printer (generate a printout)
- Output to a peripheral device (e.g., computer) via the interface port

### Output to the Display and Control Unit

The display is divided into 6 sections:

Line for metrological data	
Bar graph	Weight unit display
Measured value line	Symbol display
Symbol display	Text line

- Line for metrological data
- Bar graph
- Measured value line
- Weight unit display
- Symbol display
- Text line

Line for Metrological Data (when used as a legal measuring instrument)

This line shows:

- Max 4200 g** - Maximum balance capacity (e.g., 4,200 g)
- Min 10 g** - Minimum balance capacity; the weight must not go below this limit when the balance is used in legal metrology (e.g., 10 g)
- e= 0.1 g** - Verification scale interval of the balance; irrelevant if the balance is not used in legal metrology (e.g., 0.1 g)
- d= 0.01 g** - Readability: Indicates the actual scale interval (display increment of the balance) (e.g., 0.01 g)

### Bar Graph

In the bar graph, weighing results are displayed either

- as a percentage of the maximum balance capacity, or
- in relation to a target value, with tolerance limits indicated.

### Measured Value Line

This line displays:

- 1234.56** - The current weight readout (digits bordered with a broken line are invalid in use for legal metrology)
- 01-30-13** - Information on the balance and display and control unit (e.g., version numbers)
- 96-AbC 1** - Data entered by the user (e.g., lot number)







## Weight Unit Display

This line shows:

- kg** – Current weight unit (e.g., kg)
- pcs** – Designation of other units of measure (e.g., piece count)
- NET**  – Operating status (e.g., net weight; printing)
- o** – Identification of currently selected menu item



## Symbol Display

This line shows:

- isoCAL** – Indicators and warnings (e.g., isoCAL)
- %**      – Symbol of application program selected

## Text Line

This line contains:

- REPROTEST** – Explanatory text for value displayed in measured value line
- INFO** **MENU** **INPUT** – Designation of current function of the soft keys (below the arrows)
-    – Arrows indicating the soft keys designated above

## Display of “Longer” Values

You can enter values up to 20 characters in length (e.g., identification numbers). These are displayed in the measured value line; this line, however, can only show up to 8 characters at a time.

When a 20-character value is displayed, for example, the last 8 characters (13 through 20) are displayed first (in this example, the ID number is: “Shelf 5, carton 4020”).

```
ton 4020
<<-----ID----->>
```

The text line displays the name of the value (“ID”) and an arrow indicating the direction of the characters not displayed.

```
F 5, CAR
<<-----ID----->>
```

Display characters 5 through 12: Press 

```
SHEL
-----ID----->>
```

Display characters 1 through 4: Press 

## Printing a Data Record

### Purpose

You can generate a printout of weights, other measured values and identification numbers for documentation purposes. You can format the printout to meet individual requirements.

### Available Features

#### Print manually/automatically:

To print the information contained in the measured value line (weight readout, calculated value, numeric entry, alphabetic entry)

**Line format:** You can configure a data ID code of up to 6 characters for each of the values printed; this data ID code is printed at the beginning of the line

**Sample ID:** You can configure an extra line for identification of each weighed or calculated value

#### Print application parameters:

You can generate a printout of the values configured for initialization of an application before printing the measured results

#### ISO/GLP-compliant printout:

To print out parameters relating to weighing conditions

**Auto print:** To have a printout generated automatically when certain conditions are met, e.g., time elapsed, stability reached, etc.

**Print net-total:** For a printout of a component or total weight when using the "net-total" application

**Print animal weights:** For an automatic printout of animal weight, or of animal weight plus calculated weight after averaging

**Auto print +/-:** for automatic printout of a weight when it lies within preset limits at stability

### Factory Settings

#### Print manually/automatically:

Printout generated manually (by pressing ) or automatically, depending on stability parameter: Manual after stability (6 1 2)

#### Line format:

A data ID code of up to 6 characters preceding weighed or calculated values:  
For other applications/GLP (7 2 2)

#### Print application parameters:

Print one or more of the initialization values for the current application program: Off (7 1 1)

ISO/GLP-compliant printout/  
data record: Documentation of weighing conditions for each series of measurements/each lot:  
Off (8 1 1)

#### Auto print:

Automatic printout of weighed/  
calculated values:  
not a factory setting; see  
"Print manually/automatically" (6 1 2)  
Not possible to stop by pressing  
 (6 2 2)  
After 1 display update (6 3 1)

#### Print net-total:

Printout of component weight (net weight) or total weight (tare weight):  
Auto print net (7 3 1)

#### Print animal weights:

Automatic printout of animal weight, or of animal weight plus calculated result: On: animal wt. (3 9 2)

#### Auto print +/-:

Automatic printout of weights when within tolerance at stability:  
off (4 2 2)

- Parameter settings:  
See "Configuring the Balance"

## Print Manually/Automatically

The printout contains the current value in the measured value display (weight readout with weight unit; calculated value; numeric/alphabetic display)

+ 1530.000	g	Weight in grams
+ 58.5620	oz t	Weight in Troy ounces
+ 253	pcs	Piece count
+ 88.23	%	Percentage
+ 105.78	o	Calculated value

## Line Format

The current value displayed can be printed with a data ID code of up to 6 characters at the beginning of the line. You can use this data ID code, e.g., to designate a weight readout as a net weight (N) or a calculated value as a piece count (Qnt)

<b>ID</b>	<b>ABC123DEF456GH</b>	Identification number*
<b>L ID</b>	<b>ABC123DEF456GH</b>	Lot number (weighing series)*
<b>W ID</b>	<b>ABC123DEF456GH</b>	Weight set number*
<b>N</b>	<b>+ 1530.000 g</b>	Net value
<b>Qnt</b>	<b>+ 253 pcs</b>	Quantity
<b>Prc</b>	<b>+ 88.23 %</b>	Percentage
<b>Nom.</b>	<b>+ 2000.00 g</b>	Exact calibration weight

\* = only on ISO/GLP-compliant printouts

## Sample ID

You can have each weighed or calculated value that you print preceded by a line of text containing numbers and/or letters. You can either print this ID immediately as an alphanumeric input (press ) or store it as the sample ID (5 I soft key)

<b>S ID</b>	<b>ABC123DEF456GH</b>	Sample ID
	<b>ABC123DEF456GHI789JK</b>	Sample ID
<b>NUM</b>	<b>12345678</b>	Numeric key output when  is pressed

Sample ID (with less than 14 characters)  
Sample ID (with more than 14 characters)  
Numeric key output when  is pressed

## Print Application Parameters

You can generate a printout of one or more of the values configured for initialization of an application as soon as you initialize the balance. This can include such values as nRef, wRef, pRef, etc.

<b>nRef</b>	<b>10 pcs</b>	Counting: Reference sample quantity
<b>wRef</b>	<b>1.23456 g</b>	Counting: Average piece weight
<b>pRef</b>	<b>80 %</b>	Weighing in percent: Reference percentage
<b>Wxx%</b>	<b>1200.00 g</b>	Weighing in percent: Reference weight
<b>mDef</b>	<b>10</b>	Animal weighing: Number of subweighs for averaging
<b>MuL</b>	<b>0.00347</b>	Animal weighing: multiplication factor
<b>Setp</b>	<b>+ 1000.035 g</b>	Over/under checkweighing: Target weight
<b>Min</b>	<b>+ 981.054 g</b>	Over/under checkweighing: Lower limit
<b>Max</b>	<b>+ 1020.063 g</b>	Over/under checkweighing: Upper limit
<b>N1</b>	<b>+ 278.11 g</b>	Net-total: net weight
<b>T2</b>	<b>+ 1821.48 g</b>	Net-total: tare weight
<b>Comp7</b>	<b>+ 278.11 g</b>	Net-total: weight of 7th component
<b>Tot.cpt</b>	<b>2117.56 g</b>	Net-total: total weight of components (only for ISO/GLP-compliant records)

Counting: Reference sample quantity  
Counting: Average piece weight  
Weighing in percent: Reference percentage  
Weighing in percent: Reference weight  
Animal weighing: Number of subweighs for averaging  
Animal weighing: multiplication factor  
Over/under checkweighing: Target weight  
Over/under checkweighing: Lower limit  
Over/under checkweighing: Upper limit  
Net-total: net weight  
Net-total: tare weight  
Net-total: weight of 7th component  
Net-total: total weight of components (only for ISO/GLP-compliant records)

## Auto Print

You can have the weight readout (or the value displayed in the measured value line) printed automatically; this printout can be generated after a certain number of display updates; you can also configure whether or not the auto-print function is dependent on the stability parameter. The display update frequency depends on both the model of the balance and the current operating state.

```
N      + 1530.00 g
S ID   12345678901234
Stat
Stat   L
Stat   H
```

Net weight  
Sample ID  
Display blank  
Display underload  
Display overload

## Print Net-Total

When you run the net-total application, you can have the weight of the last component weighed (net value) or the total weight (tare value) printed automatically.

```
Comp1 + 1821.48 g
```

First net weight

## Print Animal Weights

When using the animal weighing application, you can have the results printed automatically upon completion of the averaging process. You can also have both the weight and the calculated result printed.

```
mDef          10
Mul           0.00347
x-Net +      1530.00 g
x-Res +         5.30 o
```

Number of subweighs for averaging  
Multiplication factor  
Result of averaging  
Calculated result

## Auto Print +/-

With the over/under checkweighing application, you can have the result printed automatically if it lies within a defined range (acceptable value).

```
N      + 1530.000 g
Setp   + 1000.035 g
Min     +  981.054 g
Max     + 1020.063 g
N      + 1010.147 g
```

Net weight  
Target weight  
Lower limit  
Upper limit  
Printout of acceptable values

## Data Output Functions

### Printing a Data Record

Print for use in legal-for-trade applications:

You can configure the scale operating menu to generate a printout that conforms to the regulations for use in legal metrology (last digit marked) on a Sartorius printer:

- YDPO11S: 5 5 4
- YDPO2: 5 5 5
- YDPO3: 5 5 6

## ISO/GLP-compliant Printout/Record

You can have the parameters pertaining to the ambient weighing conditions printed before (GLP header) and after (GLP footer) the values of a weighing series.

These parameters include:

- Date
- Time at the beginning of a weighing series
- Balance manufacturer
- Balance model
- Model serial number
- Software version
- Lot ID (weighing series no.)
- Time at the conclusion of the weighing series
- Field for operator signature

## Operating the Balance with an ISO/GLP-capable Documentation Device (Printer)

You can connect a special printer from Sartorius to your balance for printing ISO/GLP-compliant records.

This printer, called "Data Printer" (order no.: YDPO3-OCE), offers the following features:

- ISO/GLP function can be switched on and off
- Date/time
- ID no. for identification of workstation/operator
- Documentation includes balance-specific data

### Note:

The time indicated on the printout consists of only hours and minutes.

For ISO/GLP-compliant documentation with a computer, you will need special software. Contact Sartorius for a detailed description for creating this software.

```

-----
28.06.1997      16:12

                SARTORIUS
Mod.            LP4200S
Ser. no.        60419914
Ver. no.        01-30-09

ID             12345678901234
-----
L ID  12345678901234
nRef   10 pcs
wRef   1.35274 g
Qnt    + 235 pcs
Qnt    + 4721 pcs
S ID   12345678901234
Qnt    + 567 pcs
-----
28.06.1997      16:13

Name :
-----

```

Dotted line  
Date/time  
(only with the YDPO3-OCE printer)  
Balance manufacturer  
Balance model  
Balance serial number  
Software version  
(display and control unit)  
Balance ID no.  
Dotted line  
Weighing series no.  
Application initialization value  
Application initialization value  
Counting result  
Counting result  
ID for counting result  
Counting result  
Dotted line  
Date/time  
(only with the YDPO3-OCE)  
Field for operator signature  
Blank line  
Dotted line  
Blank line  
Blank line

## Interface Description

### Purpose

Your Master<sup>PRO</sup> balance comes equipped with an interface port for connection to a computer or other peripheral device.

You can use an on-line computer to change, start and/or monitor the functions of the balance and the application programs.

The interface port also has four data output port lines for the over/under checkweighing program.

### Warning When Using Pre-wired RS-232 Connecting Cables!

RS-232 cables purchased from other manufacturers often have incorrect pin assignments for use with Sartorius balances. Be sure to check the pin assignment against the chart on the right before connecting the cable, and disconnect any lines marked "Internally Connected" (e.g., pin 6). Failure to do so may damage or even completely ruin your balance and/or peripheral device.

## Features

Type of interface:	Serial interface
Operating mode:	Full duplex
Standard:	RS-232
Transmission rates:	150; 300; 600; 1,200; 2,400; 4,800; 9,600; 19,200 baud
Parity:	Space, odd, even
Character format:	1 start bit, 7-bit ASCII, parity, 1 or 2 stop bits
Handshake:	2-wire interface: via software (XON/XOFF); 4-wire interface: via hardware handshake lines (CTS/DTR)
Data output format of the balance:	16 or 22 characters

### Factory settings:

Transmission rate:	1,200 baud	(5 1 4)
Parity:	Odd	(5 2 3)
Stop bits:	1 stop bit	(5 3 1)
Handshake:	Hardware 1 character after CTS	(5 4 3)
Print manually/automatically:	Manual with stability	(6 1 2)
Stop automatic printing:	Not possible	(6 2 2)
Automatic printout, time-dependent:	After 1 display update	(6 3 1)
Line format:	For other applications/GLP	(7 2 2)

### Preparation

- See page 68 for the pin assignment chart

## Line Format (Data Output Format)

You can output the values displayed in the measured value line and the weight unit with or without a data ID code

Example: Without data ID code

**+ 253 pcs**

Example: With data ID code

**Qnt + 253 pcs**

Configure this parameter in the Setup menu under item 72.

The output with data ID code has 16 characters; without data ID code, 22 characters.

## Output Format with 16 Characters

Display segments that are not activated are output as spaces.

Characters without a decimal point are output without a decimal point.

The following characters can be output, depending on the characters displayed on the balance:

### Normal Operation

Position	1	2	3	4	5	6	7	8	9	10	11	12	13	14	15	16
	+	*	D	D	D	D	D	D	D	D	*	U	U	U	CR	LF
or	-	.	.	.	.	.	.	.	.	.	.	*	*	*		
or	*	*	*	*	*	*	*	*	*	*						
or					0	0	0	0	0	0						

- \*: Space
- D: Digit or letter
- U: Unit symbol
- CR: Carriage return
- LF: Line feed

### Special Codes

Position	1	2	3	4	5	6	7	8	9	10	11	12	13	14	15	16
	*	*	*	*	*	*	-	-	*	*	*	*	*	*	CR	LF
or							H	H								
or							L	L								
or							C									

- \*: Space
- -: Weight; all numbers shown in stable readout
- H: Overload
- H H: Overload during checkweighing
- L: Underload
- L L: Underload during checkweighing
- C: Calibration/adjustment

### Error codes

Position	1	2	3	4	5	6	7	8	9	10	11	12	13	14	15	16
	*	*	*	E	r	r	*	#	#	#	*	*	*	*	CR	LF

- \*: Space
- # # #: Error code number

Data output example: + 1255.7 g

Position	1	2	3	4	5	6	7	8	9	10	11	12	13	14	15	16
	+	*	*	*	1	2	5	5	.	7	*	g	*	*	CR	LF

- Position 1: Plus or minus sign or space
- Position 2: Space
- Positions 3–10: Weight with a decimal point; leading zeros = space
- Position 11: Space
- Positions 12–14: Unit symbol or space
- Position 15: Carriage return
- Position 16: Line feed

### Data Output with an ID Code

When data with an ID code is output, the ID code consisting of 6 characters precedes the data with the 16-character format. These 6 characters identify the following value.

1	2	3	4	5	6	7	8	9	10	11	12	13	14	15	16	17	18	19	20	21	22
I	I	I	I	I	I	+	*	D	D	D	D	D	D	D	D	*	U	U	U	CR	LF
*	*	*	*	*	*	-	.	.	.	.	.	.	.	.	.	.	*	*	*		
						*	*	*	*	*	*	*	*	*	*						
																0	0	0	0	0	0

- I: ID code character<sup>1)</sup>
- \*: Space
- D: Digit or letter
- U: Unit symbol<sup>1)</sup>
- CR: Carriage return
- LF: Line feed

<sup>1)</sup> depends on balance type; e.g., not all units and characters are available on balances verified for use in legal metrology

### Special Codes

1	2	3	4	5	6	7	8	9	10	11	12	13	14	15	16	17	18	19	20	21	22	
S	t	a	t	*	*	*	*	*	*	*	*	*	-	-	*	*	*	*	*	*	CR	LF
													H	H								
													L	L								
													C									

- \*: Space
- -: Weight; all numbers shown in final, stable readout
- H: Overload
- H H: Overload during checkweighing
- L: Underload
- L L: Underload during checkweighing
- C: Calibration/adjustment

### Error codes

1	2	3	4	5	6	7	8	9	10	11	12	13	14	15	16	17	18	19	20	21	22
S	t	a	t	*	*	*	*	*	E	r	r	*	#	#	#	*	*	*	*	CR	LF

- \*: Space
- # # #: Error code number

### Unit symbol U<sup>1)</sup>

		No stability parameter
g		Grams
k g		Kilograms
c t		Carats
l b		Pounds
o z		Ounces
o z t		Troy ounces
t l h		Hong Kong taels
t l s		Singapore taels
t l t		Taiwanese taels
G N		Grains
d w t		Pennyweights
m g		Milligrams
/ l b		Parts per pound
t l c		Chinese taels
m o m		Mommes
K		Austrian carats
t o l		Tola
b a t		Baht
M S		Meshgal
%		Percent
p c s		Pieces (piece count)

### ID code characters<sup>1)</sup>

<b>Stat</b>	Status
<b>T2</b>	Application tare memory
<b>N</b>	Net weight (T1 = 0)
<b>N1</b>	Net weight (T1 0)
<b>Qnt</b>	Quantity
<b>Prc</b>	Percentage
<b>nRef</b>	Reference sample quantity
<b>pRef</b>	Reference percentage
<b>wRef</b>	Average piece weight
<b>Wxx%</b>	Reference percentage weight
<b>NUM</b>	Numeric input
<b>Compxx</b>	Component no. xx in net-total component mode
<b>Tot.c.p</b>	Total weight in net-total component mode
<b>mDef</b>	No. of subweighs for animal weighing
<b>Mul</b>	Multiplication factor for animal weighing
<b>x-Net</b>	Result in animal weighing
<b>x-Res</b>	Calculated result in animal weighing
<b>Setp</b>	Target value for checkweighing
<b>Min</b>	Lower limit for checkweighing
<b>Max</b>	Upper limit for checkweighing



## Data Input Format

You can connect a computer to your balance to send commands via the balance interface port to control balance functions and applications.

The commands sent are control commands and may have different formats; e.g., control commands can have up to 26 characters. Each character must be transmitted according to the settings configured in the Setup menu for data transmission.

## Format for Control Commands

Format 1: Esc ! CR LF

Format 2: Esc ! # \_ CR LF

Format 3: Esc ! # & (max. 20 &) & \_ CR LF

Format 4: Esc ! \_ CR LF

Esc:	Escape	_:	Underline (ASCII: 95)
!:	Command character	CR:	Carriage return
#:	Number	LF:	Line feed
&:	Number or letter	max:	Depends on command character; i.e., parameter: once the max. length is reached, input received via the interface port is cut off, rather than rejected as for a key input

## Format 1

!	Meaning
K	Weighing mode 1
L	Weighing mode 2
M	Weighing mode 3
N	Weighing mode 4
O	Block keys
P	Print
R	Unblock keys
S	Restart
T	Tare [TARE]
Z	Internal calibration/adjustment

## Format 2

!#	Meaning
f0	Function key [G]
f1	Function key [CAL]
f2	Function key [F]
f3	Zero (separate zeroing key)
f4	Tare (separate zeroing key)
s3	Function key [CF]
x0	Perform internal calibration
x1	Print balance model
x2	Print weighing cell serial number
x3	Print weighing cell software version
x4	Print display and control unit software version
x5	Print balance ID number
x6	Print weight set number
x7	Print lot number (weighing series ID)

## Format 3

(not allowed in the Setup menu)

!#	Meaning
z5	Input balance ID number
z6	Input weight set number
z7	Input lot number

## Format 4

!	Meaning
t	Text input in display

## Synchronization

During data communication between the balance and an on-line device (computer), messages consisting of ASCII characters are transmitted via the interface. For error-free data communication, the parameters for baud rate, parity, handshake mode and character format must be the same for both units.

You can set these parameters in the Setup menu so that they match those of the on-line device. You can also define parameters in the balance to make data output dependent on various conditions. The conditions that can be configured are described under each of the application program descriptions.

If you do not plug a peripheral device into the balance interface port, this will not generate an error message.

## Handshake

The balance interface (Sartorius Balance Interface = SBI) has transmit and receive buffers. You can define the handshake parameter in the Setup menu:

- Hardware handshake (CTS)
- Software handshake (XON, XOFF)

### Hardware Handshake

With a 4-wire interface, 1 more character can be transmitted after CTS (Clear to Send).

### Software Handshake

The software handshake is controlled via XON and XOFF. When a device is switched on, XON must be transmitted to enable any connected device to communicate.

When the software handshake is configured in the Setup menu, the hardware handshake becomes active after the software handshake.

The data transmission sequence is as follows:

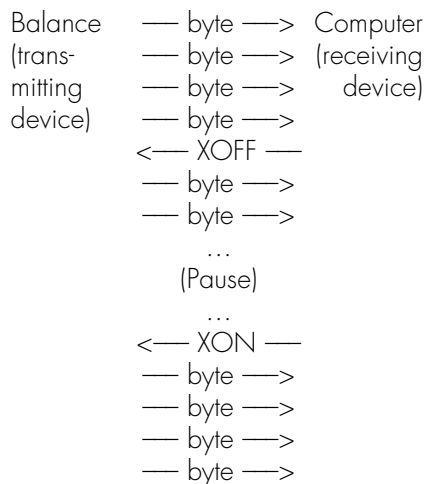

## Transmitting Device:

Once XOFF has been received, it prevents further transmission of characters. When XON is received, it re-enables the transmitting device to send data.

## Receiving Device:

XOFF is transmitted after the 26th character has been stored. To prevent too many control commands from being received at one time, XON is not transmitted until the buffer has transmitted all but 14 characters.

If the device addressed does not understand the control command, the SBI receiving device activates DTR (Data Terminal Ready) after 6 more characters have been received. The busy signal is deactivated by XON (14 characters).

### Activating Data Output

You can define the data output parameter so that output is activated either when a print command is received or automatically and synchronous with the balance display or at defined intervals (see application program descriptions and auto print settings).

### Data Output by Print Command

The print command can be transmitted by pressing  or by a software command (Esc P).

### Automatic Data Output

In the “auto print” operating mode, data are output to the interface port without a print command. You can choose to have data output automatically at defined print intervals with or without the stability parameter. Whichever parameter you select, the data will be output as the readouts appear on the balance display. The display update frequency depends on both the model of the balance and the current operating state.

If you select the auto print setting, data will be transmitted immediately the moment you turn on the balance. In the Setup menu, you can configure whether this automatic output can be stopped and started by pressing .

## Pin Assignment Chart

### Female Interface Connector:

25-position D-Submini, DB25S,  
with screw lock hardware for cable  
gland

### Male Connector Required:

(please use connectors with the same  
specifications)

25-pin D-Submini, DB25S,  
with integrated shielded cable clamp  
assembly (Amp type 826 985-1C)  
and fastening screws  
(Amp type 164 868-1)

### Pin Assignment Chart:

Pin 1:	Signal Ground
Pin 2:	Data Output (TxD)
Pin 3:	Data Output (RxD)
Pin 4:	Signal Return (TxD/RxD)
Pin 5:	Clear to Send (CTS)
Pin 6:	Internally Connected
Pin 7:	Internal Ground
Pin 8:	Internal Ground
Pin 9:	Reset $\_In^{**}$ )
Pin 10:	- 12 V
Pin 11:	+ 12 V
Pin 12:	Reset $\_Out^{**}$ )
Pin 13:	+ 5 V
Pin 14:	Internal Ground
Pin 15:	
Pin 16:	
Pin 17:	
Pin 18:	
Pin 19:	
Pin 20:	Data Terminal Ready (DTR)
Pin 21:	Supply Voltage Ground "COM"
Pin 22:	Not Connected
Pin 23:	Not Connected
Pin 24:	Supply Voltage Input + 15 ... 25 V
Pin 25:	+5 V

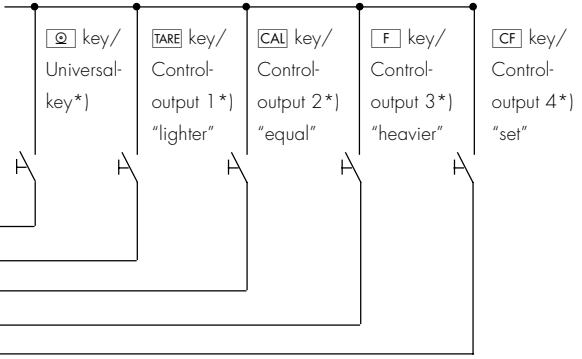

\*) = See "Additional Functions" for information on changing  
pin assignments

\*\*\*) = Hardware restart

## Cabling Diagram

- Diagram for interfacing a computer or different peripheral device to the balance using the RS-232/V24 standard and cables up to 15 m (50 ft.) long

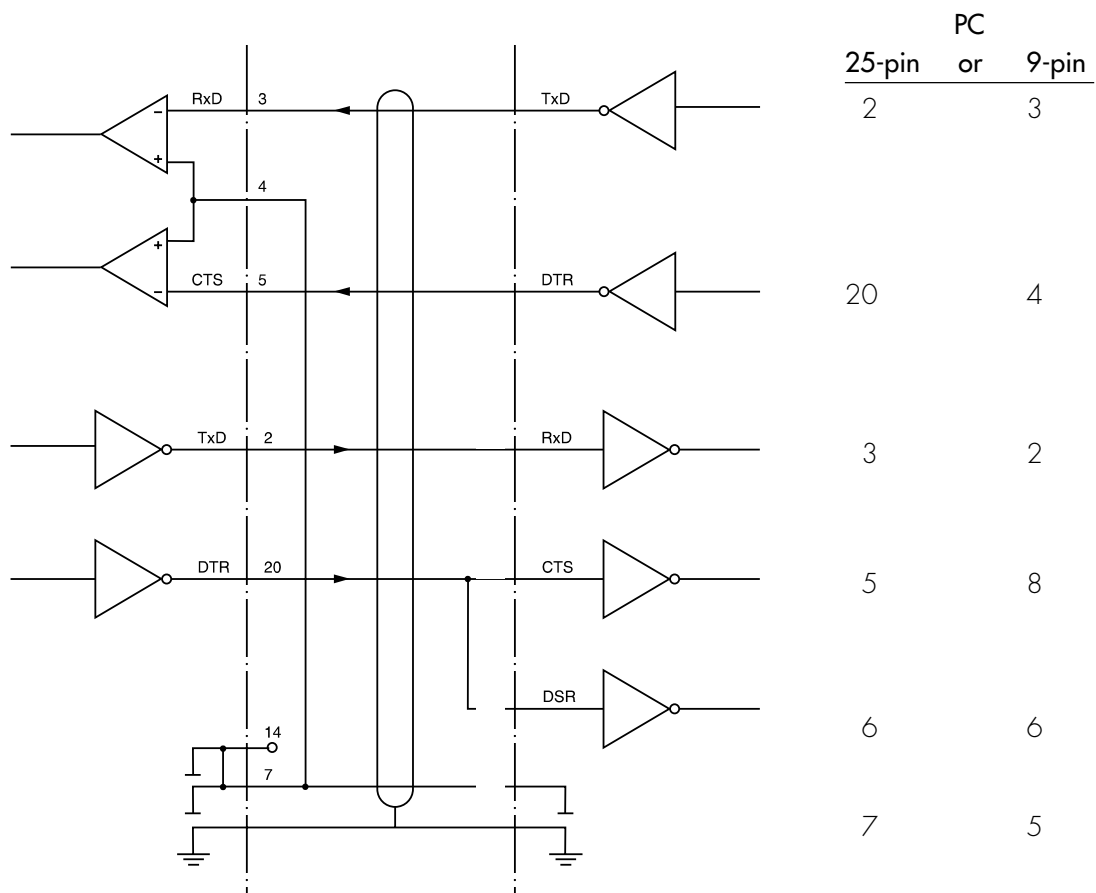
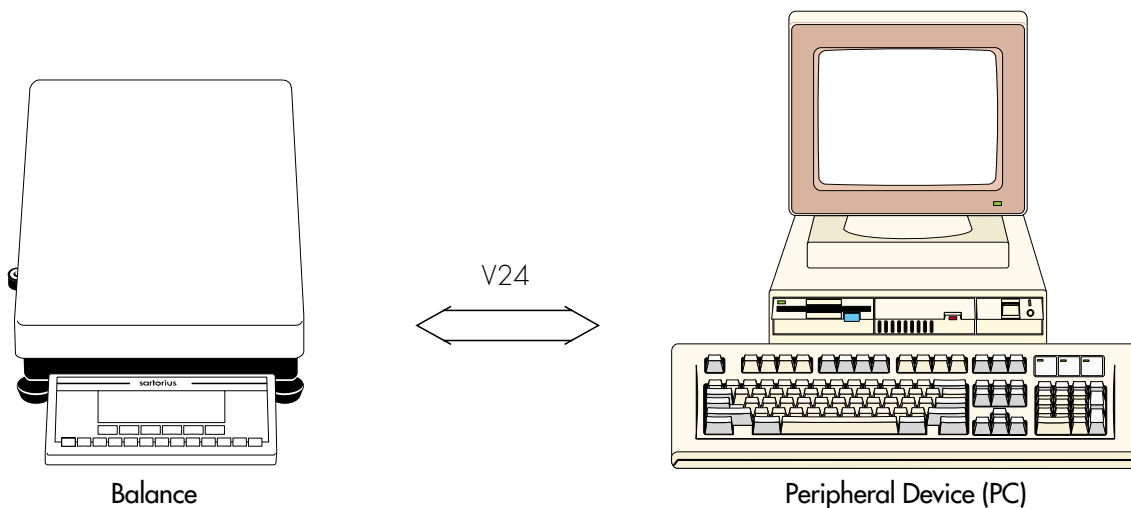

Type of cable: AWG 24 specification

## Additional Functions

### Password

You can block access to parameter settings in the Setup menu and to the ID-code input function, as well as to the exact calibration weight, by assigning a password.

Enter the password by selecting *INPUT* in the Setup menu. See "Configuring the Balance" for a detailed description.

### Protecting Menu Parameters

In the Setup menu, you can define whether menu parameters are:

- accessible for changes (*ALTERABLE, B 1 1*)
- can be read only (*READABLE, B 1 2*)

### Acoustic Signal

An acoustic signal is emitted when you press a key. When the key pressed is allowed, the signal is a single beep tone; when it is not allowed, this is signaled by a double beep (key does not initiate a function). In the Setup menu, you can configure whether

- the acoustic signal should sound (*ON, B 2 1*), or
- the acoustic signal should not sound (*OFF, B 2 2*)

### Blocking the Keys

When you operate the balance via an on-line computer, it is advisable that you block the keys on the display and control unit. In the Setup menu, you can configure whether

- the keys are active (*KEYS UNBLOCKED, B 3 1*),
- the keys are blocked (*KEYS BLOCKED, B 3 2*), except for *SETUP* and *↻*, or
- the alphanumeric keys are blocked (*ALPHANUM. BLOCKED, B 3 3*).

### Universal Switch for Remote Control

You can connect an external universal switch to the interface port of your balance (e.g., a foot switch) for remote control of the functions listed below. In the Setup menu, you can configure which function is to be controlled via remote switch:

- Printing (*PRINT KEY FUNCT., B 4 1*)
- Taring (*TARE KEY FUNCTION, B 4 2*)
- Calibration (*CAL KEY FUNCTION, B 4 3*)
- Function key (*F KEY FUNCTION, B 4 4*)
- Delete/cancel (*CF KEY FUNCTION, B 4 5*)
- Toggling (*TOGGLE KEY FUNCT., B 4 6*)

### Display Backlighting

You can have the display backlit for improved readability of displayed values. In the Setup menu, you can configure whether the

- display backlighting is on (*ON, B 5 1*),
- display backlighting is off (*OFF, B 5 2*), or
- display backlighting switches off automatically if there is no change in the readout for at least 4 minutes (*AUTO OFF AFT. 4 MIN., B 5 3*)

### Power-On Mode

You can configure the balance so that once a power supply is connected,

- the balance is turned off (*OFF/ON/STANDBY, B 6 1* or *OFF/ON, B 6 2*), or
- the balance switches on automatically (*AUTO ON, B 6 4*)

You can also set the configurations so that when the balance is switched off after use, it is

- off – not in balances with a weighing capacity  $\geq 16$  kg (*OFF/ON, B 6 2*), or
- in the standby mode (*OFF/ON/STANDBY, B 6 1*)

When you turn on the balance, a self-test of the functions is run (test is displayed; the bar graph is shown)

After the self-test has been completed, the weighing range of the balance is displayed (line for metrological data shows different maximum values)

### Automatic Shutoff

When parameter *B 6 2* is selected in the Setup menu, you can configure whether





- the balance will shut off automatically after 4 minutes without use (*AFTER 4 MIN., B 7 1*), or
- automatic shutoff is deactivated (*OFF, B 7 2*)

## Interface Port Input/Output







You can connect a checkweighing display and a remote universal switch to the interface port (factory setting).

When you connect a remote universal switch, you need to change the following parameters.

### Pin Assignments for the Female Interface Connector

Pin	Input Function (8 8 1)	Output Function (8 8 2)
15	 key	Remove universal switch (see below)
16	 key	Control output port 1: lighter
17	 key	Control output port 2: equal
18	 key	Control output port 3: heavier
19	 key	Control output port 4: "set"

### Remote universal switch

Function	Menu setting
 key	8 4 1
 key	8 4 2
 key	8 4 3
 key	8 4 4
 key	8 4 5
 key	8 4 6

See "Pin Assignment Chart" in the chapter entitled "Overview" for detailed information.

## Printing an ISO/GLP-compliant Record

In the Setup menu, you can configure whether

- no ISO/GLP-compliant record will be printed (OFF, 8 10 1),
- an ISO/GLP-compliant record will be printed after calibration/adjustment (ONLY FOR CAL./ADJ., 8 10 2), or
- every printout will be an ISO/GLP-compliant record (ALWAYS ON, 8 10 3)

## Undoing All Parameter Changes – Reset Function

There is a factory setting for each parameter. In the Setup menu, you can configure whether

- menu factory settings will be restored after exiting Setup (RESTORE, 9 1 1), or
- menu factory settings will not be restored after exiting Setup (DO NOT RESTORE, 9 1 2)

## MP8 Interface Emulation

### Purpose

With the MP8 interface emulation you can connect peripheral devices of the MP8 generation that have separate AC power supplies, such as the 73822... Data Control terminal, a YFC... Flow Rate Controller, a YDI50Z Data Input dedicated keyboard, etc., to your LP series balance.

### Available Features

- The balance can only be used to determine weights
- The interface communicates exclusively in the MP8 binary protocol.
- Select application programs for use with the MP8 under item 3 in the balance operating menu.
- The Index 2 program for MP8 can be selected under item 4 of the balance operating menu
- The following parameters remain accessible as before:
  - Weighing parameters [1-x-x]
  - Extra functions [8-x-x]
  - Reset function [9-x-x](see "Setting Parameters (Menu)" in the chapter entitled "Configuring the Balance")
- "MP8 interface" not allowed during use in legal metrology. When the menu access switch is sealed, the MP8 interface will not function.

### Factory Settings of the Parameters

(special settings for MP8 functions)

Program selection: *MPB: 3- 1- 1*

Program index 2: *1 IND. 2. 1*

### Preparation

- Turn on the balance:  
Press
- > All display segments light up briefly

Switch to the MP8 interface:

- Press
- Select balance operating menu: *MENU* soft key (press the key)
- Select and confirm the *BALANCE MENU*: press the and then the key
- Confirm *FACTORY SETTING*: key
- Select and confirm *MPB mode [9- 1-9]*  
Press or key, repeatedly if necessary; then press

- Press

Parameter Settings for the MP8 Interface

- Press
- Select the balance operating menu: *MENU* soft key (press the key)
- Select and confirm:
  - *3 APPLICATION PROG. 1 APP. SELECTION:*  
*1 MPB 3- 1- 1* or  
...  
*9 MPB 3- 1-9* or  
*10 MPB 3-2- 1* or  
...  
*18 MPB 3-2-9* or  
*19 MPB 3-3- 1* or  
...  
*27 MPB 3-3-9*
  - *4 PROGRAM-INDEX; 2 IND. 2:*  
*1 IND. 2. 1* or  
*2 IND. 2. 2* or  
*3 IND. 2. 3* or  
*4 IND. 2. 4*
  - *5 INTERFACE:*  
*1 BAUD RATE*  
*1 150 BAUD* or  
*2 300 BAUD* or  
*3 600 BAUD* or  
*4 1,200 BAUD* or  
*5 2,400 BAUD* or  
*6 4,800 BAUD* or  
*7 9,600 BAUD* or  
*2 PARITY*  
*2 SPACE* or  
*3 ODD* or  
*4 EVEN*
  - *6 PRINT WEIGHING*  
*1 PRINT MAN./AUTO*  
*1 MANUAL WITHOUT STABILITY* or  
*2 MANUAL WITH STABILITY* or  
*4 AUTOMATIC WITHOUT STABILITY* or  
*5 AUTOMATIC AT STABILITY*
- Store settings and exit the Setup menu: Press



## Error Codes

Error codes are displayed in the main display or application display for 2 seconds.  
The program then returns automatically to the previous mode (e.g., weighing).

Display	Cause	Solution
No segments appear on the display	No AC power is available The AC adapter is not plugged in Automatic shutoff configured in the Setup menu (code <b>B 7 1</b> )	Check the AC power supply Plug in the AC adapter Press <b>[I/O]</b> to turn on the balance or select code <b>B 7 2</b> in the Setup menu ("no automatic shutoff")
<b>H</b>	The load exceeds the balance's capacity	Unload the balance
<b>L</b> or <b>Err 54</b>	The weighing pan is not in place	Place the weighing pan on the balance
<b>Err 01</b> <b>DISPLAY RANGE</b>	Data output not compatible with output format	Change the configuration in the Setup menu
<b>Err 02</b> <b>CAL.N.POSSIBLE</b>	Calibration/adjustment criterion not met, e.g., – not tared – the balance is loaded	Calibrate only when zero is displayed Press <b>[TARE]</b> to tare Unload the balance
<b>Err 03</b> <b>CAL./ADJ. INTERRUPT</b>	Calibration/adjustment could not be completed within a certain time	Allow the balance to warm up again and repeat the adjustment process
<b>Err 06</b> <b>INT.WT. DEFECTIVE</b>	Built-in calibration weight is defective	Contact your local Sartorius Service Center
<b>Err 07</b> <b>FUNCTION BLOCKED</b>	Function not allowed in balances verified for use in legal metrology	Contact your local Sartorius Service Center for information on having the settings changed
<b>Err 08*</b> <b>ZERO RANGE</b>	The load on the balance is too heavy to zero the readout	Check whether the "power-on zero range" is set
<b>Err 09*</b> <b>NOT ALLOWED</b>	Taring is not possible when the gross weight is $\leq$ zero	Zero the balance
<b>Err 10</b> <b>TARE FCT. BLOCKED</b>	The tare key is blocked when there is data in the tare memory (e.g., when running the net-total application); the tare functions cannot be accessed simultaneously	Press <b>[CF]</b> to clear the tare memory; then you can tare by pressing <b>[TARE]</b>
<b>Err 11</b> <b>TARE 2 BLOCKED</b>	Tare memory not allowed	Check the tare value entered
<b>Err 12</b> <b>TARE MAX.</b>	Tare stored in memory greater than weighing range or range limits	Check sample/container
<b>Err 17</b> <b>ADJ.-WT. MAX.</b>	Internal adjustment is not possible because the preload is too heavy	Reduce the preload or change the configuration

\* = occurs only when balance is operated via the SBI interface (ESC f3\_/f4\_)

Display	Cause	Solution
<b>Err 30</b> PRINT FCT. BLOCKED REF.WT. TOO LIGHT	Interface port for printer output is blocked	Contact your local Sartorius Service Center
UPD. NOT POSSIBLE	Error in storing reference weight (with the counting or weighing-in-percent application)	Weight too light or there is no sample on the balance
NO NUM. VALUE XXXXX TOO LOW XXXXX TOO HIGH	Reference sample updating not possible (with the counting application)	See "Counting" in "Operating the Balance" for reference updating criteria
TOO MANY CHARACTERS	Input wrong (for any application program), e.g., alphabetic input not allowed	Follow the instructions for the application programs
<b>Err 10</b> x = 1: x = 2: x = 3: x = 4:	Input text too long	Allowable text lengths, incl. decimal point: – S ID and L ID: 20 characters max. – W ID: 14 characters max. for weights
All segments displayed continuously	Key is stuck  Key pressed when turning on the balance: CF, CAL, S, F 0, 3, 4, 9 2, 5, 6, Q, TARE – right 1, 7, 8, ABC, TARE – left Either SETUP was pressed when you turned on the balance, or this key is stuck	Contact your local Sartorius Service Center Release key
<b>Err 340</b>	Operating parameter (EEPROM) is wrong	Contact your local Sartorius Service Center
<b>no IIP</b>	Weighing cell (platform) defective	Contact your local Sartorius Service Center
BLOCKED	Function blocked	None
The special code ◀ remains displayed	None of the keys has been pressed since the balance was turned on	Press a key
The weight readout changes constantly	Unstable ambient conditions  Too much vibration, or the balance is exposed to a draft  A foreign object is caught between the pan and the balance housing	Set up the balance in another area  Change Setup configurations to adapt the balance to the ambient conditions  Remove the foreign object
The weight readout is obviously wrong	The balance has not been calibrated/adjusted  The balance was not tared before weighing  The balance is not level  The dust cover is caught under the weighing pan	Calibrate/adjust the balance  Tare before weighing  Level the balance  See "Replacing the Dust Cover" in the chapter "Care and Maintenance"

If any other errors occur, contact your local Sartorius Service Center!

## Care and Maintenance

### Service

Regular servicing by a Sartorius technician will extend the service life of your balance and ensure its continued weighing accuracy. Sartorius can offer you service contracts, with your choice of regular maintenance intervals ranging from 1 month to 2 years.

### Repairs

Repair work must be performed by trained service technicians. Any attempt by untrained persons to perform repairs may lead to hazards for the user.

### Cleaning

- ⚠ Make sure that no dust or liquid enters the balance housing
- ⚠ Do not use any aggressive cleaning agents (solvents or similar agents)
- Unplug the AC adapter from the wall outlet (mains supply)
- If you have an interface cable connected to the balance port, unplug it from the port
- Carefully remove any sample residue/spilled powder by using a brush or a hand-held vacuum cleaner
- Clean the balance using a piece of cloth which has been wet with a mild detergent (soap)
- After cleaning, wipe down the balance with a soft, dry cloth

### Replacing the Dust Cover

> Instructions for replacing a damaged dust cover

#### For LP Series Balances with a Round Glass Draft Shield

- Remove the following parts from the balance:
  - Draft shield cover
  - Glass draft shield cylinder
  - Weighing pan
  - Pan support
  - Shield disk: turn clockwise and lift off
  - Old dust cover
- Place the new dust cover on the balance and press down on the front and back along the edges until it is seated firmly
- Place the shield disk on the balance and turn it counterclockwise
- Follow the above instructions in reverse order when placing remaining parts back on the balance.

#### For LP Series Balances with a Rectangular Weighing Pan and a Weighing Capacity $\leq 12$ kg

- Remove the following parts from the balance:
  - Weighing pan
  - Pan draft shield (depending on balance model)
  - Old dust cover
- Place the new dust cover over the balance
- Follow the above instructions in reverse order when placing remaining parts back on the balance.

⚠ The dust cover must not touch the weighing pan

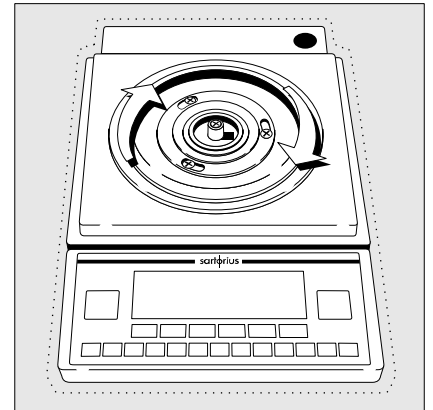

### Safety Inspection

If there is any indication that safe operation of the balance with the AC adapter is no longer warranted:

- Turn off the power and disconnect the equipment from AC power immediately
- > Lock the equipment in a secure place to ensure that it cannot be used for the time being

Safe operation of the balance with the AC adapter is no longer ensured when:

- there is visible damage to the AC adapter
- the AC adapter no longer functions properly
- The AC adapter has been stored for a relatively long period under unfavorable conditions

In this case, notify your nearest Sartorius Service Center or the International Technical Support Unit based in Goettingen, Germany. Maintenance and repair work may only be performed by service technicians who are authorized by Sartorius and who

- have access to the required maintenance manuals
- have attended the relevant service training courses

## Replacement of the Backup Battery

Spare backup battery in the display and control unit (soldered to PCB)

Type: VL 2020; manufacturer: Panasonic. To be replaced by trained service technicians only.

### CAUTION:

Danger of explosion if battery is incorrectly replaced. Replace only with the same or equivalent type recommended by the manufacturer. Dispose of used batteries according to the manufacturer's instructions.

## Instructions for Recycling

To ensure adequate protection for safe shipment, the Master<sup>pro</sup> balance has been packaged to the extent necessary using environmentally friendly materials. After successful installation of the balance, you should return this packaging for recycling.

For information on recycling options, including recycling of old weighing equipment and disposal of used batteries, contact your municipal waste disposal center or local recycling depot.

Overview

General Views of the Balances

LP1200S (-OCE), LP620S (-OCE), LP220S (-OCE), LP620P (-OCE), LP3200D

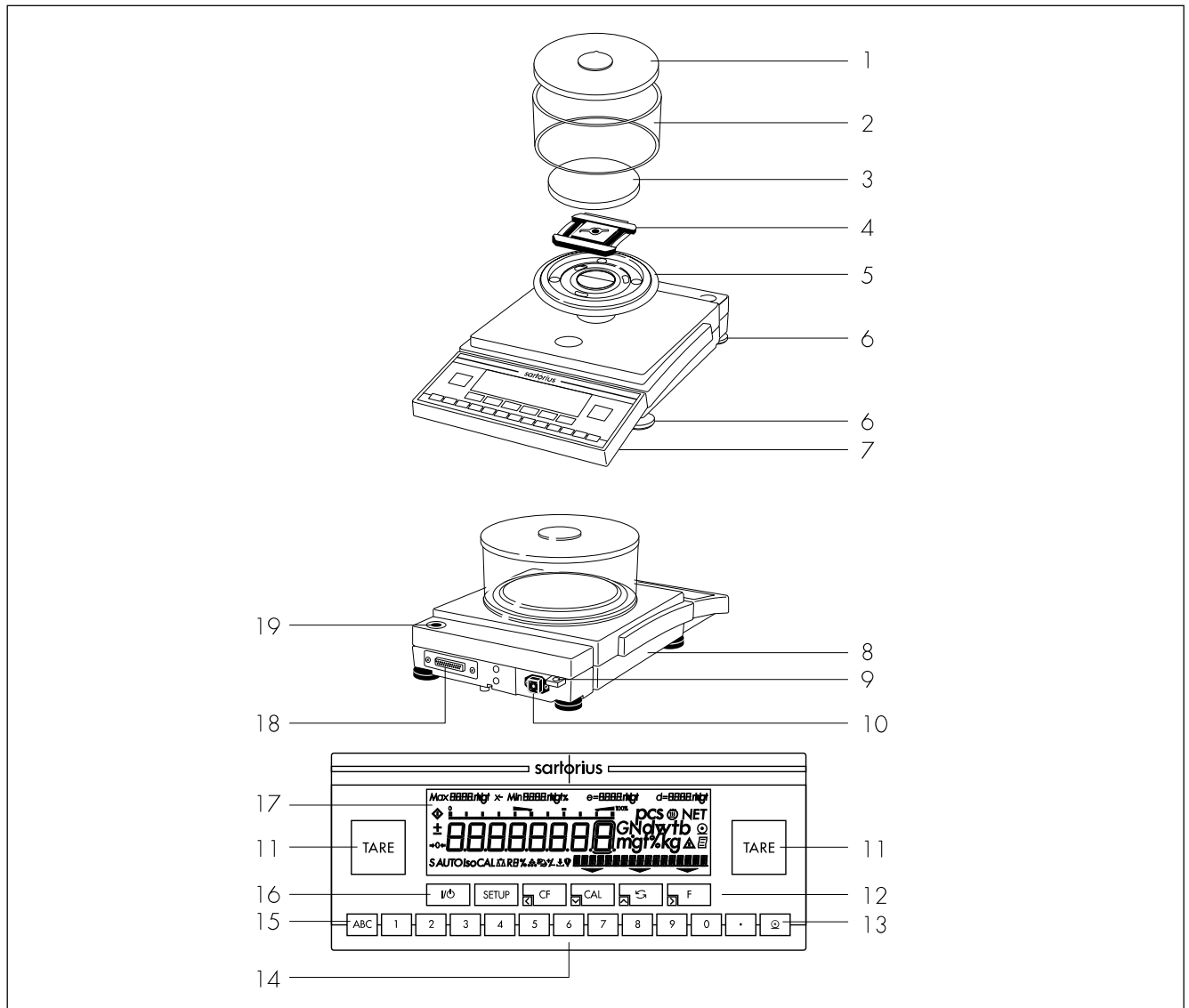

No.	Designation	Order no. for spare part	No.	Designation	Order no. for spare part
1	Draft shield cover	69 LP0002	11	Tare key	
2	Glass draft shield cylinder	69 14290	12	Function keys	
3	Weighing pan	69 LP0004	13	Print key	
4	Pan support – LP 3200D: – LP 1200S, LP 620, LP 220S:	69 LP0006 69 LP0005	14	Keys for numeric input	
5	Shield disk	69 LP0003	15	Toggle key for alphabetic input	
6	Leveling foot	69 B20005	16	On/off key	
7	Display and control unit		17	Display	
8	Metrological ID label (only on verified models or models acceptable for legal metrological verification)		18	Interface port	
9	Lug for attaching an antitheft locking device		19	Level indicator	
10	AC jack		Not shown:		
			Dust cover		69 60LP01
			Protective caps and plugs (set)		69 B20009

## General Views of the Balances

LP8200S (-OCE), LP8200P (-OCE), LP6200S (-OCE), LP4200S (-OCE), LP2200S (-OCE), LP820 (-OCE), LP420, LP2200P (-OCE), LP5200P (-OCE), LP12000S (-OCE), LP6200 (-OCE), LP4200, LP2200 (-OCE), LP12000P (-OCE)

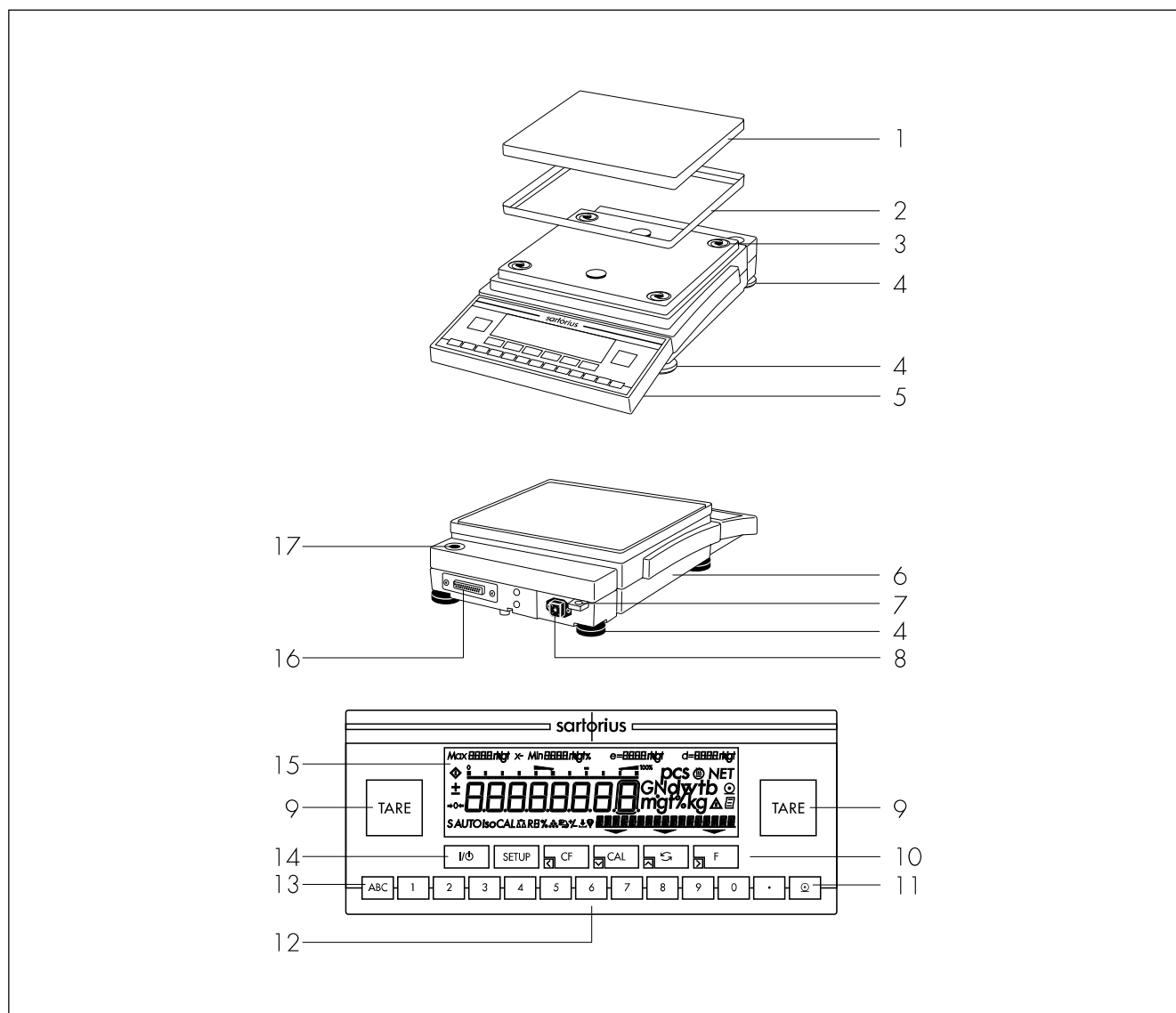

No.	Designation	Order no. for spare part	No.	Designation	Order no. for spare part
1	Weighing pan	69 LP0007	10	Function keys	
2	Pan draft shield (depending on balance model)	69 LP0008	11	Print key	
3	Shock absorber	69 LP0010	12	Keys for numeric input	
4	Leveling foot	69 B20005	13	Toggle key for alphabetic input	
5	Display and control unit		14	On/off key	
6	Metrological ID label (only on verified models or models acceptable for legal metrological verification)		15	Display	
7	Lug for attaching an antitheft locking device		16	Interface port	
8	AC jack		17	Level indicator	
9	Tare key			Not shown:	
				Dust cover	69 60LP02
				Protective caps and plugs (set)	69 B20009

General Views of the Balances

LP16000S (-OCE), LP34000P (-OCE), LP34 (-OCE)

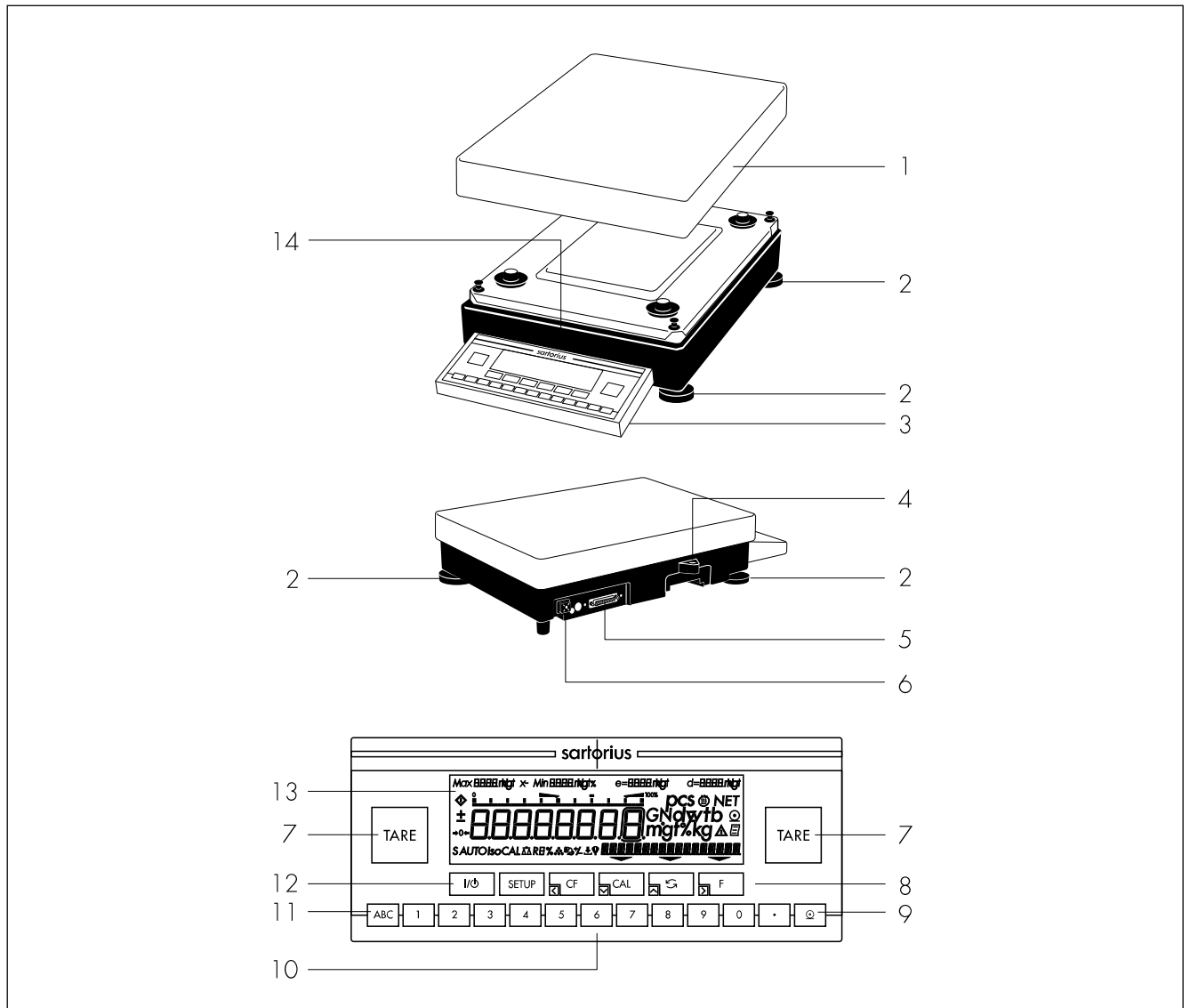

No.	Designation	Order no. for spare part	No.	Designation
1	Weighing pan	69 LC0107	10	Keys for numeric input
2	Leveling foot	69 LC0093	11	Toggle key for alphabetic input
3	Display and control unit		12	On/off key
4	Level indicator		13	Display
5	Interface port		14	Metrological ID label (only on verified models or models acceptable for legal metrological verification)
6	AC jack			
7	Tare key			
8	Function keys			
9	Print key			

## Description of the Keys

 Key    On/off switch

Switches the display on/off.  
The balance remains in the standby mode.

 Key    Settings for Configuring the Balance

- Access to the Setup menu
- Stores settings and exits Setup menu

You can select:

*INFO*

Display basic information about the equipment (e.g., model name, serial no., software version)

*MENU*

Balance operating menu with plain English prompts for adapting the balance to individual requirements

*INPUT*

For entering identifying information (e.g., balance ID)

 Key    Clear

This key is generally used to interrupt/cancel functions:

- Delete keyboard input and clear memory
- Interrupt calibration/adjustment routines
- Return application program to previous status

 Key    Calibration/Adjustment

Press this key to select and start calibration/adjustment functions.

 Key    Toggle

This key toggles the display readout between a weight and a calculated value (counting, readout in percent, calculated result)

 Key

Start an Application

Further instructions on running the applications when this key is pressed are contained in the chapter entitled "Operating the Balance;" refer to the section pertaining to the particular program.

 Keys

For moving around within the parameter submenus for Info, Menu and Input in the Setup menu.

 Keys    Tare

Two large keys for initiating the tare function. Ideally situated for both left-handed and right-handed operation. Sets the readout to zero. With balances that have the "PolyRange" weighing range structure, the fine range is available when this key is pressed.

 Key

Press this key to enter alphabetic characters and/or special characters (\*, /, space, etc.).

 Keys

For numeric input

 Key

Define the decimal point position

 Key    Data Output

Press this key to output data via the interface to a Sartorius Data Printer or a computer.



## Menu Structure

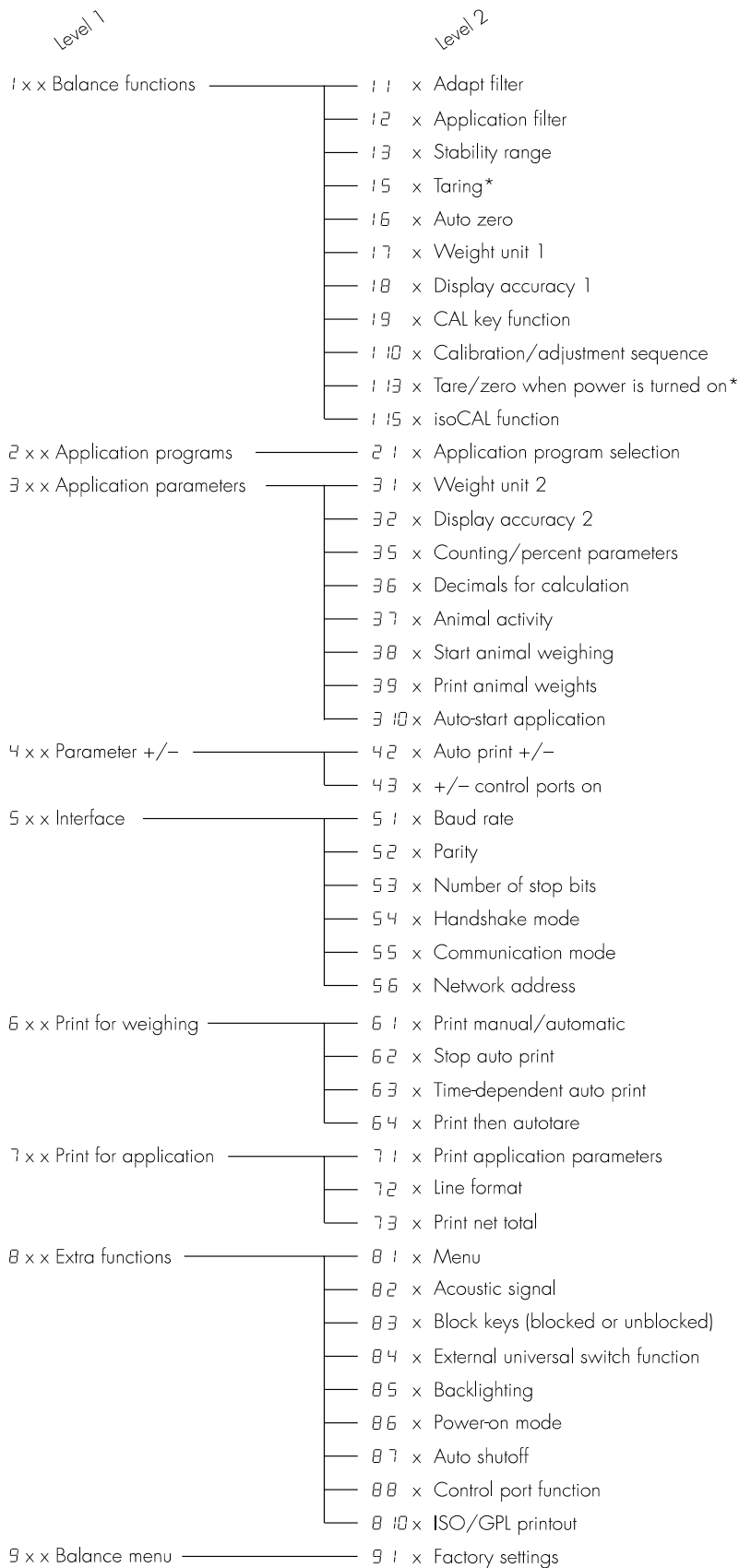

\* = setting cannot be changed in balances used for legal metrology

## Specifications

### General Specifications

AC power source/power requirements	AC adapter, 230 or 115 V, +15%... - 20%	
Frequency	48 - 60 Hz	
Allowable ambient operating temperature	0...+40 °C (273...313 K, 32 °F...104 °F)	
Operating temperature range	+ 10...+ 30 °C	
Dust and water protection rating according to EN 60529*	IP54 (protected against harmful dust deposits and splashes of water)	
Adaptation to ambient conditions	By selection of 1 of 4 optimized filter levels	
Display update (depends on the filter level selected)	0.1 - 0.4	
Power consumption	16 VA: maximum; 9 VA: average	
Hours of operation with fully charged YRB 06 Z external battery pack, approx.	14 h	
Selectable weight units	Grams, kilograms, carats, pounds, ounces, Troy ounces, Hong Kong taels, Singapore taels, Taiwanese taels, grains, pennyweights, milligrams, parts per pound, Chinese taels, mommes, Austrian carats, tola, baht and mesghal	
Selectable application programs	Mass unit conversion, counting, weighing in percent, net-total formulation, animal weighing, over/under checkweighing, recalculation	
Built-in interface	RS-232 C Format: 7-bit ASCII, 1 start bit, 1 or 2 stop bits Parity: odd, even or space Transmission rates: 150 to 19,200 baud Handshake: Software or hardware mode	

\* = specially protected dust-tight and washdown resistant AC adapter; see the section on "Accessories"

### Specifications of the Individual Models

Model		LP1200S	LP620S	LP220S	LP620P	LP3200D
Readability	g	0.001	0.001	0.001	0.001/0.002/ 0.005	0.001/0.01
Weighing capacity	g	1,200	620	220	120/240/620	1,010/3,200
Tare range (subtractive)	g	- 1,200	- 620	- 220	- 620	- 3,200
Repeatability (standard deviation)	≤±g	0.001	0.001	0.001	0.001/0.001/ 0.003	0.001/0.01
Linearity	≤±g	0.002	0.002	0.002	0.002/0.002/ 0.005	0.002/0.01
Sensitivity drift within +10...+30 °C	≤±/K	2 • 10 <sup>-6</sup>				
Response time (average)	s	1.5				
External calibration weight (of at least accuracy class...)	g	1,000 (E2)	500 (E2)	200 (E2)	500 (F1)	1,000 (E2)
Other allowable external calibration weights (of at least accuracy class...)	g	-	300, 400, 600 (E2)	100 (E2)	200, 300, 400, 600 (F1)	2,000, 3,000 (E2)
Pan size	mm Ø	130				
Dimensions (W x D x H)	mm	240x360x147				
Net weight, approx.	kg	8.3	6.9	6.9	6.9	8.4

Model		LP8200S	LP8200P	LP6200S	LP4200S	LP2200S
Readability	g	0.01	0.01/0.02/0.05	0.01	0.01	0.01
Weighing capacity	g	8,200	2,000/4,000/8,200	6,200	4,200	2,200
Tare range (subtractive)	g	- 8,200	- 8,200	- 6,200	- 4,200	- 2,200
Repeatability (standard deviation)	≤±g	0.01	0.01/0.01/0.03	0.01	0.01	0.01
Linearity	≤±g	0.02	0.02/0.02/0.05	0.02	0.02	0.02
Sensitivity drift within +10...+30 °C	≤±/K	2 • 10 <sup>-6</sup>				
Response time (average)	s	2	2	1.5	1.5	1.5
External calibration weight (of at least accuracy class...)	g	5,000 (E2)	5,000 (F1)	5,000 (E2)	2,000 (E2)	2,000 (F1)
Other allowable external calibration weights (of at least accuracy class...)	g	6,000; 7,000; 8,000 (E2)	-	6,000 (E2)	3,000; 4,000 (E2)	1,000 (F1)
Pan size	mm	218x200				
Dimensions (W x D x H)	mm	240x360x86				
Net weight, approx.	kg	6.5				

Model		LP820	LP420	LP2200P	LP5200P	LP16000S
Readability	g	0.01	0.01	0.01/0.02/ 0.05	0.01/0.02/ 0.05/0.1	0.1
Weighing capacity	g	820	420	400/800/ 2,200	1,200/2,400/ 3,800/5,200	16,000
Tare range (subtractive)	g	- 820	- 420	- 2,200	- 5,200	- 16,000
Repeatability (standard deviation)	≤±g	0.01	0.01	0.01/0.01/ 0.03	0.01/0.02/ 0.05/0.05	0.1
Linearity	≤±g	0.01	0.01	0.02/0.02/ 0.05	0.02/0.02/ 0.05/0.1	0.2
Sensitivity drift within +10...+30 °C	≤±/K	2 • 10 <sup>-6</sup>				
Response time (average)	s	1.5				
External calibration weight (of at least accuracy class...)	g	500 (F2)	200 (F2)	2,000 (F2)	2,000 (F1)	10,000 (F1)
Other allowable external calibration weights (of at least accuracy class...)	g	600; 700; 800 (F2)	300; 400 (F2)	1,000 (F2)	3,000; 4,000; 5,000 (F1)	11,000 to 16,000 (F1)
Pan size	mm	218x200	218x200	218x200	218x200	307x417
Dimensions (W x D x H)	mm	240x360x86	240x360x86	240x360x86	240x360x86	307x538x121
Net weight, approx.	kg	6.5	6.5	6.5	6.5	13.8

Model		LP1 2000S	LP6200	LP4200	LP2200
Readability	g	0.1	0.1	0.1	0.1
Weighing capacity	g	12,000	6,200	4,200	2,200
Tare range (subtractive)	g	- 12,000	- 6,200	- 4,200	- 2,200
Repeatability (standard deviation)	≤±g	0.05			
Linearity	≤±g	0.2	0.1	0.1	0.1
Sensitivity drift within +10...+30 °C	≤±/K	4 • 10 <sup>-6</sup>			
Response time (average)	s	1			
External calibration weight (of at least accuracy class...)	kg	5,000 (F1)	5,000 (F2)	2 (F2)	2 (F2)
Other allowable external calibration weights (of at least accuracy class...)	kg	6,000 to 12,000 (F1)	4,000; 6,000 (F2)	3; 4 (F2)	1 (F2)
Pan size	mm	218x200			
Dimensions (W x D x H)	mm	240x360x86			
Net weight, approx.	kg	6.5			

Model		LP34000P	LP12000P	LP34
Readability	g	0.1/0.2/0.5	0.1/0.2/0.5	1
Weighing capacity	g	8,000/ 16,000/ 34,000	3,000/6,000/ 12,000	34,000
Tare range (subtractive)	g	- 34,000	- 12,000	- 34,000
Repeatability (standard deviation)	≤±g	0.1/0.2/0.5	0.1/0.1/0.3	0.5
Linearity	≤±g	0.2/0.2/0.5	0.1/0.2/0.5	1
Sensitivity drift within +10...+30 °C	≤±/K	2 • 10 <sup>-6</sup>	4 • 10 <sup>-6</sup>	2 • 10 <sup>-6</sup>
Response time (average)	s	1.5	1	1
External calibration weight (of at least accuracy class...)	kg	10 (F2)	5 (F2)	10 (F2)
Other allowable external calibration weights (of at least accuracy class...)	kg	15; 20; 25; 30 (F2)	6; 7; 8; 9; 10; 11; 12 (F2)	15; 20; 25; 30 (F2)
Pan size	mm	307x417	218x200	307x417
Dimensions (W x D x H)	mm	307x538x121	240x360x86	307x538x121
Net weight, approx.	kg	13.8	6.5	13.8

## Verified Models with EC Type Approval

### General Specifications

AC power source/power requirements	AC adapter, 230 or 115 V, + 15%... -20%		
Frequency	48 – 60 Hz		
Dust and water protection rating according to EN 60529 <sup>1)</sup>	IP54 (protected against harmful dust deposits and splashes of water)		
Adaptation to ambient conditions	By selection of 1 of 4 optimized filter levels		
Display update	0.1 – 0.4 (depends on the filter level selected)		
Power consumption	16 VA: maximum; 9 VA: average		
Hours of operation with fully charged YRB 06 Z external battery pack, approx.	14 h		
Selectable weight units	Grams, kilograms		
Selectable application programs	Mass unit conversion, counting, weighing in percent, net-total formulation, animal weighing, over/under checkweighing, recalculation		
Built-in interface	RS-232 C		
	Format:	7-bit ASCII, 1 start bit, 1 or 2 stop bits	
	Parity:	odd, even, or space	
	Transmission rates:	150 to 19,200 baud	
	Handshake:	Software or hardware mode	

<sup>1)</sup> specially protected dust-tight and washdown resistant AC adapter; see the section on "Accessories"

### Specifications of the Individual Models

Model		LP1200S-OCE	LP620S-OCE	LP220S-OCE	LP620P-OCE
Type		MD BF 100, BD BF	BA BF 500, BD BF	BA BF 500, BD BF	BA BF 500, BD BF
Accuracy class*		Ⓘ	Ⓜ	Ⓜ	Ⓜ
Scale interval d*	g	0.001	0.001	0.001	0.001/0.002/ 0.005
Max. weighing capacity*	g	1,200	620	220	120/240/620
Verification scale interval e*	g	0.01	0.01	0.01	0.01
Min. capacity*	g	0.1	0.02	0.02	0.02
Tare range (subtractive)		≤100% of the max. weighing capacity			
Application range according to CD*	g	0.2 – 1,200	0.02 – 620	0.02 – 220	0.02 – 620
Response time (average)	s	1.5			
Allowable operating temperature range		0 ... +40°C (273 ... 313 K, 32°F ... 104°F) with the isoCAL function <sup>2)</sup>			
External calibration weight value (of at least accuracy class...)	g	1,000 (E2)	–	–	–
Pan size	mm	Ø 130			
Dimensions (W x D x H)	mm	240x360x147			
Net weight, approx.	kg	8.3	6.9	6.9	6.9

<sup>2)</sup> = With the isoCAL function deactivated, the verified balance can only be used within the limited temperature range (can only be modified by the Sartorius Service Center):

For balances of accuracy class Ⓘ: +15°C to +25°C

For balances of accuracy class Ⓜ: +10°C to +30°C (50°F to 86°F)

\* CD = Council Directive 90/384/EEC for non-automatic weighing instruments used within the European Economic Area

Model	LP8200S-OCE	LP8200P-OCE	LP6200S-OCE	LP4200S-OCE	LP2200S-OCE
Type	BD BF	BD BF	MA BF 200, BD BF	MA BF 200, BD BF	BA BF 500, BD BF
Accuracy class*	Ⓘ	Ⓘ	Ⓘ	Ⓘ	Ⓘ
Scale interval d*	g 0.01	0.01/0.02/ 0.05	0.01	0.01	0.01
Max. weighing capacity*	g 8,200	2,000/4,000/ 8,200	6,200	4,200	2,200
Verification scale interval e*	g 0.1				
Min. capacity*	g 0.5				
Tare range (subtractive)	≤100% of the max. weighing capacity				
Application range according to CD*	g 0.5 – 8,200	0.5 – 8,200	0.5 – 6,200	0.5 – 4,200	0.5 – 2,200
Response time (average)	s 2	2	1.5		
Allowable operating temperature range	0 ... +40°C (273 ... 313 K, 32°F ... 104°F) with the isoCAL function <sup>1)</sup>				
Pan size	mm 218 x 200				
Dimensions (W x D x H)	mm 240 x 360 x 86				
Net weight, approx.	kg 6.5				

Model	LP820-OCE	LP2200P-OCE	LP5200P-OCE	LP12000S-OCE	LP6200-OCE
Type	BA BF 500, BD BF	BA BF 500, BD BF	MA BF 200, BD BF	BA BF 500, BD BF	BA BF 500, BD BF
Accuracy class*	Ⓘ	Ⓘ	Ⓘ	Ⓘ	Ⓘ
Scale interval d*	g 0.01	0.01/0.02/ 0.05	0.01/0.02/ 0.05/0.1	0.1	0.1
Max. weighing capacity*	g 820	400/800/ 2,200	1,200/2,400/ 3,800/5,200	12,000	6,200
Verification scale interval e*	g 0.1	0.1	0.1	1	1
Min. capacity*	g 0.5	0.5	0.5	5	5
Tare range (subtractive)	≤100% of the max. weighing capacity				
Application range according to CD*	g 0.5 – 820	0.5 – 2,200	0.5 – 5,200	5 – 12,000	5 – 6,200
Response time (average)	s 1.5	1.5	1.5	1	1
Allowable operating temperature range	0 ... +40°C (273 ... 313 K, 32°F ... 104°F) with the isoCAL function <sup>1)</sup>				
Pan size	mm 218 x 200				
Dimensions (W x D x H)	mm 240 x 360 x 86				
Net weight, approx.	kg 6.5				

<sup>1)</sup> = With the isoCAL function deactivated, the verified balance can only be used within the limited temperature range (can only be modified by the Sartorius Service Center):

For balances of accuracy class Ⓘ: +15°C to +25°C

For balances of accuracy class Ⓘ: +10°C to +30°C (50°F to 86°F)

\* CD = Council Directive 90/384/EEC for non-automatic weighing instruments used within the European Economic Area

Model		LP2200-OCE	LP12000P-OCE	LP16000S-OCE	LP34000P-OCE	LP34-OCE
Type		BA BF 500, BD BF	BA BF 500, BD BF	BB BD 523	BB BD 523	BB BD 523
Accuracy class*		Ⓜ	Ⓜ	Ⓜ	Ⓜ	Ⓜ
Scale interval d*	g	0.1	0.1/0.2/0.5	0.1	0.1/0.2/0.5	1
Max. weighing capacity*	g	2,200	3,000/6,000/ 12,200	16,000	8,000/16,000/ 34,000	34,000
Verification scale interval e*	g	0.1	1	1	1	1
Min. capacity*	g	5	5	5	5	50
Tare range (subtractive)		≤100% of the max. weighing capacity				
Application range according to CD*	g	5 – 2,200	5 – 12,000	5 – 16,000	5 – 34,000	5 – 34,000
Response time (average)	s	1	1	1.5	1.5	1
Allowable operating temperature range		+10 ... +30°C (50°F ... 86°F)				
Selectable weight units		Grams, kilograms	Grams, kilograms	Grams, kilograms		Kilograms
Pan size	mm	307x417				
Dimensions (W x D x H)	mm	307x538x121				
Net weight, approx.	kg	6.5	6.5	13.8	13.8	13.8

\* CD = Council Directive 90/384/EEC for non-automatic weighing instruments used within the European Economic Area

## Accessories (Options)

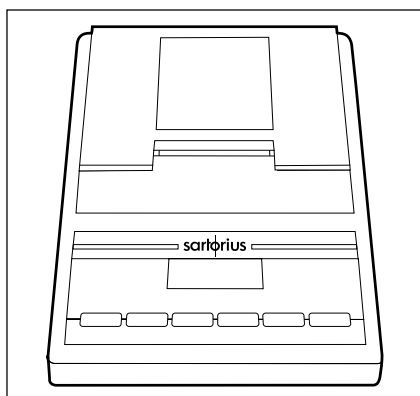

### Product

#### Data printer

with date/time, statistical evaluation data, transaction counter functions and LCD

can be used in legal metrology

Order No.

YDP03-OCE

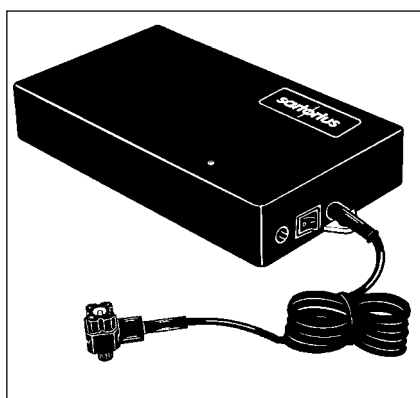

#### External rechargeable battery pack

has a battery-level indicator (LED);  
can be recharged using the AC adapter  
(time it takes to charge the discharged  
battery pack: 15 hours);  
see "Specifications" for hours of operation  
can be used in legal metrology

YRB06Z

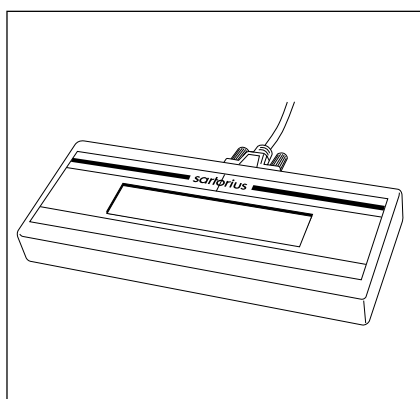

#### Remote display as a second indicator

(weight readout only)

> can be connected via the interface port  
– LCD, reflective  
– LCD for overhead projectors, transmissive  
can be used in legal metrology

YRD02Z

YRD13Z

#### 3-segment checkweighing display

conveniently shows whether a sample  
(amount filled) is within the tolerance limits  
can be used in legal metrology

YRD11Z

#### Draft shield chamber

for the LP 1200S, LP 3200D, LP 620S,  
LP 620P and LP 220S

YDS01LP

#### Density determination kit

for the LP 1200S, LP 3200D, LP 620S,  
LP 620P and LP 220S





YDK01LP

#### Calibration weights

for all LP balances; extensive assortment,  
optionally available with officially recognized  
DKD certificates

Information on  
request



Product	Order No.
<b>SartoConnect</b> data transfer software; with RS-232 standard cable; for direct input of weighing data into an application program (e.g., such as Excel)	YSC01L
<b>Standard operating procedure</b> to ensure correct operation and handling of the balance in quality assurance systems	YSL01E
<b>AC adapter, model ING-2</b> with IP65 protection rating (dust-tight and washdown-resistant)	
for 230 V	6971889
for 120 V	6971500
<b>Hanger for below-balance weighing</b> for the LP 16000S, LP 34000P and LP 34	YSH01B
<b>Universal remote control switch</b> for remote control of one of the following functions (configured in the balance Setup menu):  TARE,  CAL,  F,  CF, 	
<b>Foot switch with T-connector</b>	YFS01
<b>Hand switch with T-connector</b>	YHS02
<b>T-connector</b>	YTC01
<b>Cable for connecting the weighing cell to a separate display and control unit (length: 2.70 m)</b> for balances with a weighing capacity $\leq 12$ kg for balances with a weighing capacity $\geq 16$ kg	YCC01-19M3 YCC01-18M3
<b>Support arm</b> (for raised display configuration) for balances with a weighing capacity $\leq 12$ kg for balances with a weighing capacity $\geq 16$ kg	YDH01LP YDH02LP
<b>Weighing bowls:</b> Made of chrome-nickel steel; without pouring spout; for all models with a weighing capacity $> 400$ g: – 3,000 ml capacity – 1,000 ml capacity – 500 ml capacity	641213 641211 641212
<b>Carrying case</b> for balances with a weighing capacity $\leq 12$ kg	YDB01LP

## Declarations of Conformity

### The CE Mark on Sartorius Equipment

In 1985, the Council of the European Community approved a resolution concerning a new approach to the technical harmonization and standardization of national regulations. The organization for monitoring compliance with the directives and standards concerning the CE marking is governed in the individual EU Member States through the implementation of the EC Directives adopted by the respective national laws. As of December 1993, the scope of validity for all EC Directives has been extended to the Member States of the European Union and the Signatories of the Agreement on the European Economic Area.

Sartorius complies with the EC Directives and European Standards in order to supply its customers with weighing instruments that feature the latest advanced technology and provide many years of trouble-free service.

The CE mark may be affixed only to weighing instruments and associated equipment that comply with the applicable Directive(s):

#### Council Directive 89/336/EEC "Electromagnetic Compatibility (EMC)"

Acceptable European Standards:

Limitation of emissions:

EN 50081-1

Residential, commercial and light industry

EN 50081-2

Industrial environment

Defined immunity to interference:

EN 50082-1

Residential, commercial and light industry

EN 50082-2

Industrial environment

Important Note:

The operator shall be responsible for any modifications to Sartorius equipment and for any connections of cables or equipment not supplied by Sartorius and must check and, if necessary, correct these modifications and connections. On request, Sartorius will provide information on the minimum operating specifications (in accordance with the Standards listed above for defined immunity to interference).

#### Council Directive 73/23/EEC "Electrical Equipment Designed for Use within Certain Voltage Limits"

Applicable European Standards:

EN 60950

Safety of information technology equipment including electrical business equipment

EN 61010

Safety requirements for electrical equipment for measurement, control and laboratory use

Part 1: General requirements

If you use electrical equipment in installations and under ambient conditions requiring higher safety standards, you must comply with the provisions as specified in the applicable regulations for installation in your country.

### Weighing Instruments for Use in Legal Metrology: Directive 90/384/EEC "Non-automatic Weighing Instruments"

This Directive regulates the determination of mass in legal metrology.

For the respective Declaration of Conformity for weighing instruments that have been verified by Sartorius for use as legal measuring instruments and that have an EC Type-Approval Certificate, see the page after next.

This Directive also regulates the performance of the EC verification by the manufacturer, provided that an EC Type-Approval Certificate has been issued and the manufacturer has been accredited by an officer or a Notified Body registered at the Commission of the European Community for performing such verification.

The legal basis allowing Sartorius to perform EC verification is constituted by the EC Council Directive No. 90/384/EEC on non-automatic weighing instruments that has been in effect since January 1, 1993, in the Internal Market as well as by the Certificate of Accreditation of the Sartorius AG Quality Management System issued by the Metrology Department of the Regional Administration Office of Lower Saxony, Germany ("Niedersächsisches Landesverwaltungsamt -Eichwesen") on February 15, 1993.

For information on the CE mark on Sartorius equipment and legal regulations currently applicable in your country, and to obtain the names of the persons to contact, please ask your local Sartorius office, dealer or service center.

### **“New Installation” Service**

Initial verification is covered in our “New Installation” service package. In addition to initial verification, this package provides you with a series of important services which will guarantee you optimal results in working with your weighing instrument:

- Installation
- Startup
- Inspection
- Training
- Initial verification

If you would like Sartorius to perform initial verification of your weighing instrument, contact an authorized service representative.

### **“EC Verification” – A Service offered by Sartorius**

Our service technicians are authorized to perform the verification\* of your weighing instruments that are acceptable for legal metrological verification and can inspect and verify the metrological specifications at the place of installation within the Member States of the European Union and the Signatories of the Agreement on the European Economic Area.

### **Subsequent Verifications within the European Countries**

The validity of the verification will become void in accordance with the national regulations of the country in which the weighing instrument is used. For information on verification and legal regulations currently applicable in your country, and to obtain the names of the persons to contact, please contact your local Sartorius office, dealer or service center.

\* in accordance with the accreditation certificate issued to Sartorius AG

## DECLARATION OF TYPE CONFORMITY to Directive No. 90/384/EEC

This declaration is valid for non-automatic electromechanical weighing instruments for use in legal metrology. These weighing instruments accepted for legal metrological verification have an EC Type-Approval Certificate. The model(s) concerned is(are) listed below along with the respective type, accuracy class, and number of the EC Type-Approval Certificate:

Model	Type	Accuracy Class	EC Type-Approval Certificate No.	In Conjunction with Test Certificate	
				Type	Certificate No.
LA/LP.....-0CE	iso-TEST	(I)	D97-09-018	MD BF	D09-96.30
LA/LP.....-0CE	iso-TEST	(II)	D97-09-018	MA BF	D09-96.30
LA/LP.....-0CE	iso-TEST	(II) or (III)	D97-09-018	BA BF	D09-96.30
LA/LP.....-0CE	iso-TEST	(II) or (III)	D97-09-018	BB BD	D09-95.08
LA/LP.....-0CE	iso-TEST	(I)	D97-09-018	BC BF	D09-96.30
LA/LP.....-0CE	iso-TEST	(I), (II) or (III)	D97-09-018	BD BF	D09-96.30

SARTORIUS AG declares that its weighing instrument types comply with the requirements of the Council Directive on non-automatic weighing instruments, no. 90/384/EEC of 20 June 1990; the associated European Standard "Metrological aspects of non-automatic weighing instruments," No. EN 45501; the amended, currently valid versions of the national laws and decrees concerning legal metrology and verification in the Member States of the European Union, the EU, and the Signatories of the Agreement on the European Economic Area, which have adopted this Council Directive into their national laws; and with the requirements stipulated on the Type-Approval Certificate for verification. This Declaration of Type Conformity is valid only if the ID label on the weighing instrument has the CE mark of conformity and the green metrology sticker with the stamped letter "M" (the two-digit number in large print stands for the year in which the mark has been affixed):



If these marks are not on the ID label, this Declaration of Type Conformity is not valid. Validity can be obtained, for example, by submitting the weighing instrument for final action to be taken by an authorized representative of SARTORIUS AG. The period of validity of this Declaration of Type Conformity shall expire upon any tampering with, repair or modification of this weighing instrument or, in some Member States, on the date of expiration.

The operator of this weighing instrument shall be responsible for obtaining an authorized renewal of the verification, such as subsequent or periodic verification, of the weighing instrument for use as a legal measuring instrument.

Göttingen, 28.11.2000

SARTORIUS AG  
37070 Goettingen  
Germany

  
Executive Board  
(Warter)

  
Head of Technical Operations  
(Dr. Maaz)

DAW-113-2/02.96  
P103EM04

# Physikalisch-Technische Bundesanstalt

Braunschweig und Berlin



## EG-Bauartzulassung

*EC type-approval certificate*

Zulassungsinhaber: Sartorius AG  
*Issued to:* Weender Landstraße 94-108  
 37075 Göttingen  
 Bundesrepublik Deutschland

Rechtsbezug: § 13 des Gesetzes über das Meß- und Eichwesen (*verification act*)  
*In accordance with:* vom/dated 23. März 1992 (BGBl. I S. 711) in Verbindung mit Richtlinie  
 (*in connection with council directive*) 90/384/EWG, geändert durch (*amended by*) 93/68/EWG

Bauart: Nichtselbsttätige elektromechanische Waage  
*In respect of:* *Nonautomatic electromechanical weighing instrument*  
 Typ/type: iso-TEST  
 Genauigkeitsklasse/class I, II, III, IIII Max 0,05 kg ... 300 t  
 Option: Mehrteilungswaage, Mehrbereichswaage  
*Multi-interval instrument, multiple range instrument*

Zulassungsnummer: **D97-09-018 2. Revision**  
*Approval number:*

Gültig bis: 26.06.2007  
*Valid until:*

Anzahl der Seiten: 11  
*Number of pages:*

Geschäftszeichen: 1.14 – 00035920  
*Reference No.:*

Benannte Stelle: 0102  
*Notified Body:*

Im Auftrag  
*By order*

  
 Link



Braunschweig, 24.07.2000

Siegel  
*Seal*

**Physikalisch-Technische Bundesanstalt**

Braunschweig und Berlin

**Prüfschein***Test certificate*

**Ausgestellt für:** Sartorius AG  
*Issued to:* Weender Landstraße 94 – 108  
37075 Göttingen  
Bundesrepublik Deutschland

**Prüfgrundlage:** EN 45501 (1992), Nr.8.1,  
*In accordance with:* OIML R 76-1 (1992)

**Gegenstand:** Lastaufnehmer mit Wägezelle und Auswerteelektronik mit digitalem  
*Object:* Ausgang als Modul einer elektromechanischen Waage zum Anschluß an  
geeignete Anzeige- und Bedienterminals  
*Load receptor with load cell and electronic device with digital output as  
module of an electromechanical weighing instrument for connection to  
suitable display- and operator-terminals*  
Typ / type **BA BF, BC BF, BD BF, MA BF und MD BF**

**Kennummer:** ---  
*Serial number:*

**Prüfscheinnummer:** D09-96.30 3. Revision / *Revision 3*  
*Test certificate number:*

**Datum der Prüfung:**  
*Date of Test:*

**Anzahl der Seiten:** 9  
*Number of pages:*

**Geschäftszeichen:** 1.14 – 00070572  
*Reference No.:*

**Benannte Stelle:** 0102  
*Notified Body:*

**Im Auftrag**  
*By order*

  
Link



Braunschweig, 2000-11-16

Siegel  
*Seal*

Hinweise siehe erste Seite der Anlage, die Bestandteil des Prüfscheines ist.  
*For notes, see first page of the Annex which forms an integral part of the test certificate.*

# Physikalisch-Technische Bundesanstalt

Braunschweig und Berlin



## Test Certificate

N° D09-95.08 Revision 1

Testing of a  
**Weighing platform with electronic evaluation unit  
of type BB BD**

*issued by:* Physikalisch-Technische Bundesanstalt

*issued to:* Sartorius AG  
Weender Landstraße 94-108  
D-37075 Göttingen  
Federal Republic of Germany

*in accordance with:* EN 45501 (1992)  
(This standard essentially corresponds to OIML Recommendation  
R 76-1, 1992 Edition)

*Object tested:* Weighing platform with load cell and electronic device with digital output  
as module of an electromechanical weighing instrument for connection  
to suitable display and operator terminals

*Manufacturer:* Sartorius AG, Göttingen

The essential functions and characteristics of this module, the conditions to be observed and the specification of the relevant documentation are set out in the Appendix hereto. The module meets the requirements of EN 45501, as far as applicable; it may be used for purposes subject to legal control as module of an electromechanical weighing instrument provided that the conditions stated in EN 45501 and in the Appendix hereto are observed.

The Appendix is an integral part of this Test Certificate and comprises 5 pages.

This Revision 1 replaces Test Certificate D09-95.08 dated 15.03.1995, Reference N° 1.13-5.070.

*By order*

*Braunschweig,* 14.07.1995  
*Reference No:* 1.13-95.180

*(Brandes)*

*Seal*

Physikalisch-Technische Bundesanstalt  
Bundesallee 100  
D 38116 Braunschweig  
Federal Republic of Germany

L.S.

*Further information and legal remedy instructions see over-leaf. Test certificates are valid only with signature and seal. This test certificate shall be reproduced only in full. Partial reproduction or modification only upon permission of the Physikalisch-Technische Bundesanstalt.*

This is to certify that the above translation from the German language has been made at the Physikalisch-Technische Bundesanstalt. The original has been produced.

  
(G. Panagiotidis)  
Foreign Languages Department



Braunschweig, May 28, 1998

Z.14-755 320 34-10.93

## Plates and Markings

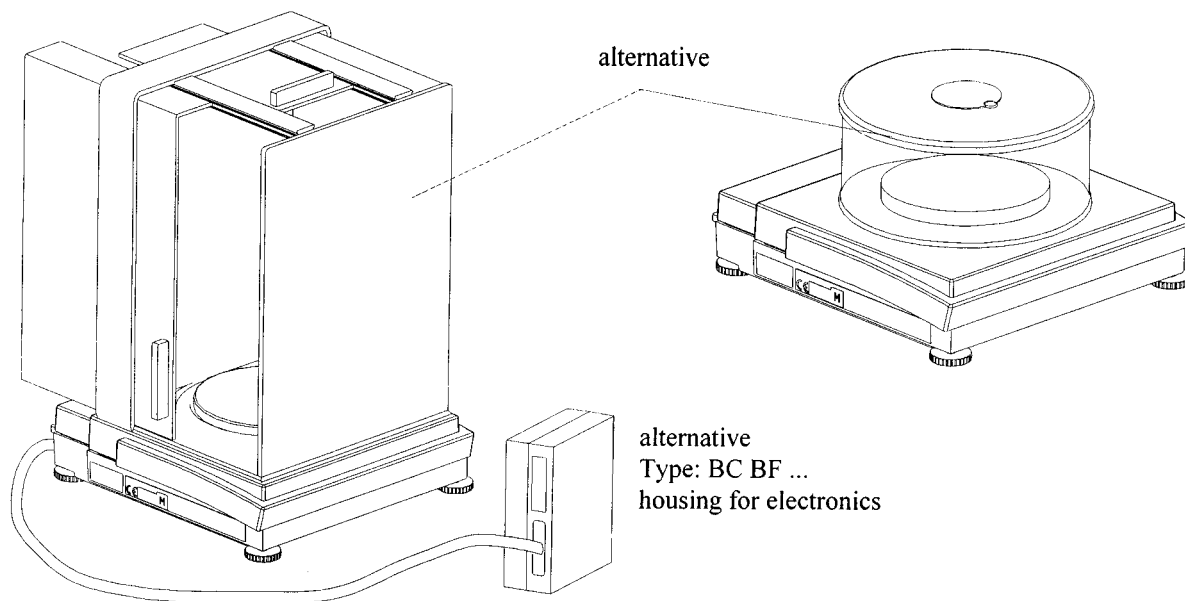

below the weighing pan (type MA BF only)

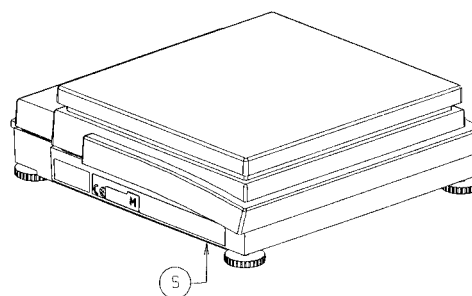
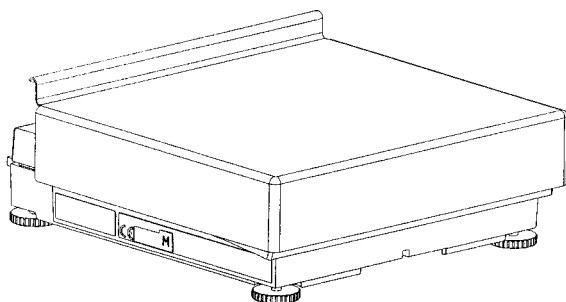
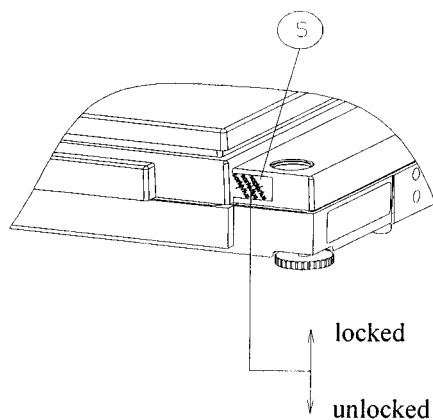
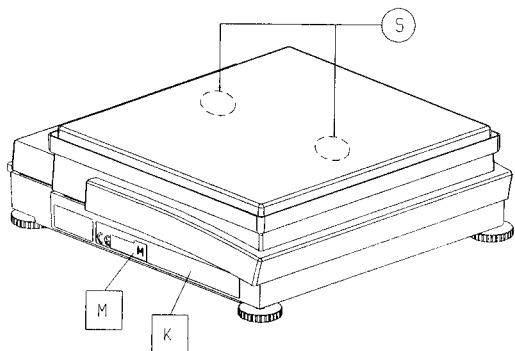

**K** Descriptive plate with CE-mark

**M** Mark for EC verification (green "M")

**S** Protective mark  
(self-adhesive mark or seal, not class I)

English version  
EC-Test certificate  
D09-96.30 3. Rev.



## Index

	Page		Page
<b>Accessories</b>	88	<b>Language setting</b>	10
Acoustic signal	70	Leveling the balance	9
Additional functions	70	Line for metrological data	56
Animal weighing	42	Line format	59
Anti-theft locking device	9	<b>Measured value line</b>	56
Application programs	31	Menu items	16
Auto print	60	Menu structure (diagram)	81
Auto print +/-	60	MP8 interface	72
Automatic calibration and adjustment (isoCAL)	29	<b>Net-total formulation</b>	40
Automatic shutoff	70	<b>Operating design</b>	3
<b>Balance-specific information</b>	10	Operating the balance	21
Basic weighing function	21	Options	88
Below-balance weighing	21	Over/under checkweighing	46
Blocking the keys	70	<b>Password</b>	70
<b>Cabling diagram</b>	69	Pin assignment chart	68
Calibration/adjustment	24	Power-on mode	70
Care and maintenance	75	Practical use	2
Cleaning	75	Print animal weights	60
Configuring the balance	10	Print application parameters	59
Connecting the balance to AC power	8	Print manually/automatically	59
Contents	2	Printing a data record	58
Control lines (checkweighing)	47	Printing an ISO/GLP-compliant record	72
Counting	33	Protecting menu parameters	70
<b>Data input format</b>	65	<b>Radio frequency interference</b>	8
Data output – activating	67	Reference sample updating	34
Data output – automatic	67	Recalculation	51
Data output – by print command	67	Repairs	70
Data output format	63	Reproducibility determination (reproTEST)	30
Data output functions	56	Reset function	71
Description of the keys	80	<b>Safety inspection</b>	75
Declarations of Conformity	90	Sample ID	59
Display – output to	56	Service	75
Display backlighting	70	Setting parameters (menu)	14
Display unit – separate	7	Setting up the balance	6
Displays of “longer” values	57	Setup parameters (overview)	16
Dust cover – replacing	75	Software handshake	66
<b>Electromagnetic compatibility</b>	90	Specifications	82
Equipment supplied	5	Storage and shipping conditions	5
Error codes	73	Remote display	88
External calibration/adjustment	27	Synchronization	66
<b>General password</b>	Appendix	<b>Text line</b>	57
General views of the balances	77	Type-approval certificate	93
Getting started	5	Toggle between weight units	31
<b>Handshake</b>	66	<b>Undoing all parameter changes –</b>	
Hardware handshake	66	Reset function	71
<b>Input user data</b>	11	Universal switch for remote control	70
Installation instructions	5	Unpacking the balance	5
Instructions for recycling	76	User data – input	11
Interface description	62	<b>Warmup time</b>	8
Interface port input/output	71	Warnings and safety precautions	2
Internal calibration/adjustment	28	Warranty	5
ISO/GLP-compliant printout/record	61	Weighing in percent	36
isoCAL	29		

# Appendix

## Entering the General Password

### Enter/Change Password

Select the Setup menu:

- > The soft keys *INFO*, *MENU* and *INPUT* are displayed in the text line

Select the user data input function: Press the *INPUT* soft key ()

- > The password prompt is displayed (*ENTER PASSW.*)

Enter the General Password (see below)

Press the *ENTER PASS.* soft key ()

- > The last 8 digits of a workstation ID (balance ID no.), if available, are displayed in the measured value line

Select password setting:  
Press

- > If a password exists, it is now displayed in the measured value line

New password: Enter the letters/numbers for the new password (8 characters max.)

To delete the password, enter a decimal point using the  key and confirm

Confirm input: Press

Exit the Setup menu:  
Press

- > Restart your application

**General Password: 40414243**

## Sartorius AG

✉ 37070 Goettingen, Germany

🏠 Weender Landstrasse 94-108, 37075 Goettingen, Germany

☎ (+49/551) 308-0, 📠 (+49/551) 308-3289

Internet: <http://www.sartorius.com>

Copyright by Sartorius AG, Goettingen, Germany.  
All rights reserved. No part of this publication  
may be reprinted or translated in any form or by any means  
without the prior written permission of Sartorius AG.

The status of the information, specifications and  
illustrations in this manual is indicated by the date  
given below. Sartorius AG reserves the right to  
make changes to the technology, features,  
specifications, and design of the equipment  
without notice.

Status: January 2001, Sartorius AG, Goettingen, Germany

Printed in Germany on paper that has been bleached without any use of chlorine - W1A000 - KT  
Publication No.: WLP6002-e01015

---

The Sartorius logo consists of the word "sartorius" in a bold, lowercase, sans-serif font. A vertical line passes through the center of the letter 'o', which is highlighted with a yellow circle.